

Instruction Manual
Voltage Piezo Amplifier
Series NPC and NPCSG
Models:
NPC3 & NPC3SG
NPC120 & NPC120SG



Read carefully before switching on the power! Please see also instructions for safety when using piezoelectric actuators and power supplies!



English version: last change 2017-02-16 by TP

Table of contents

1	Introduction.....	4
2	Certification of <i>Newport Corporation</i>	4
3	Declaration of Conformity.....	5
4	Purchased Part Package.....	6
5	Instructions for using piezo electrical elements and power supplies.....	6
6	Safety Instructions.....	7
6.1	Installation, Power Supply.....	8
6.2	Operation.....	9
6.3	Maintenance and inspection.....	10
6.4	Environmental Conditions.....	10
7	NPC3, NPC3SG, NPC120 and NPC120SG.....	10
7.1	Keywords.....	11
7.2	User Elements / Connections.....	12
7.2.1	Front Panel.....	12
7.2.2	Back Panel.....	12
7.3	Introduction.....	12
7.3.1	Block Diagram.....	13
7.3.2	Amplifier with integrated feedback controller.....	13
7.3.3	Amplifier without integrated feedback controller.....	14
7.4	Initiation.....	14
7.4.1	Main Supply Voltage.....	14
7.4.2	Connecting Piezo Actuator.....	14
7.4.3	Graphic Display NPC3, NPC3SG.....	15
7.4.4	Graphic Display NPC120, NPC120SG.....	15
8	Handling.....	16
8.1	Manual Control.....	16
8.2	Controlling via Modulation / Monitor.....	16
8.2.1	Modulation.....	16
8.2.2	Monitor NPC3SG, NPC120SG.....	16
8.2.3	Monitor NPC3, NPC120.....	17
8.3	Controlling via Interface.....	17
8.3.1	Configuration RS232.....	18
8.3.2	Command List Overview.....	18
8.3.3	Commands.....	19
8.3.4	Examples.....	21
8.3.5	Calibration of Encoder.....	22
8.4	Technical Data.....	24
8.5	Pin Assignment.....	25
8.5.1	Output Connector for Actuator D-SUB 15pin.....	25
8.5.2	MOD/MON connector D-SUB 25pin.....	25
8.5.3	RS232 D-SUB 9pin.....	26
8.5.4	USB 1.1.....	26
8.5.5	Main Supply Voltage.....	26
9	Troubleshooting.....	27
10	Your Notes.....	28

1 Introduction

This manual describes the piezo amplifiers NPC & NPCSG from **Newport Corporation**. You will also find additional information regarding piezoelectric products.

Definition: All systems from **Newport Corporation** such as electronics, actuators and optical systems are called units.

If you have any problems please contact the manufacturer of the system: **Newport Corporation**, 1791 Irvine Ave. Irvine, CA 92606. Phone: (877) 835-9620

2 Certification of Newport Corporation

The company Newport Corporation works in according to an ISO 9001:2008 certified quality management system. Its effectiveness is verified and proven by periodic audits by the BSI. Our certificate can be found at Newport.com.



This instruction manual includes important information for using piezo actuators. Please take time and read this information. Piezo positioning systems are mechanical systems with highest precision. Correct handling guarantees the precision over long time.

3 Declaration of Conformity

EU Declaration of Conformity

Product Name: Digital Piezo Amplifier

Model Number: NPC & NPCSG series

Year C€ mark affixed: 2016

Type of Equipment: Electrical equipment for measurement, control and laboratory use in industrial locations.

Manufacturer: Newport Corporation
1791 Deere Avenue
Irvine, CA 92606
U.S.A.

We hereby certify that the above described device in its conception, construction and form put by us into circulation is in accordance with all relevant essential requirements of the EMC Directive 2014/30/EU. This declaration is no longer valid if the device is modified without our consent.

The agreement with further valid guideline / regulations following for the product is explained:

Low Voltage Directive: 2014 / 35 / EU

EMC Directive: 2014 / 30 / EU

DIN EN 61010-1:2011

I, the undersigned, hereby declare that the equipment specified above conforms to the above Directives and Standards.



Gwen Briens

Sr. Director, Motion and Instruments Business

Newport Corporation

1791 Deere Ave, Irvine, CA92606 USA

4 Purchased Part Package

Please check the completeness of the delivery after receiving the shipment:

- voltage amplifier NPC3 (NPC3SG, NPC120, NPC120SG)
- wide range power supply 24VDC
- MOD/MON cable
- RS232 cable
- USB cable
- instruction manual
- CD-ROM with drivers, software and instruction manual

5 Instructions for using piezo electrical elements and power supplies

- Piezoelectric actuators from **Newport Corporation** are controlled by voltages up to 150V. These values can be quite hazardous. Therefore read the installation instructions carefully and only authorized personal should handle the power supply.
- After transportation, piezoelectric actuators should be allowed to adapt for approximately 2 hours to the room temperature before being switched on.
- Piezoelectric actuators are made from ceramic materials with and without metallic casings. The piezo-ceramic is a relatively brittle material. This should be noted when handling piezoelectrical actuators. All piezo-elements are sensitive to bending or shock forces.
- Due to the piezoelectric effect piezo-actuators can generate electrical charges by changing the mechanical load or the temperature or such actions described above.
- Piezoelectric actuators are able to work under high compressive forces. Only actuators with a pre-load can be used under tensile loads (these tensile forces must be less than the pre-load, given in the data sheet).
- Please note that the acceleration of the ceramic material (e.g., caused by fall down, discharging or high dynamic application) will occur.
- After excitation of the actuators by a voltage in the upper control range, the ceramic will move and generate an opposite high voltage after disconnection.
- Heating of the ceramic material will occur during dynamic operation and is caused by structure conditional loss processes. This may cause failure if the temperature exceeds specified values cited below.
- With increasing temperature, up to the Curie temperature (usual values approx. 140°C - 250°C), the piezoelectric effect disappears.
- Piezoelectric actuators such as stacks or other devices work electrically as a capacitor. These elements are able to store electrical energy over a long period of time (up to some days) and the stored energy may be dangerous.
- If the actuator remains connected to the drive electronics, it will be unloaded within a second after shutdown and quickly reaches harmless voltage values.
- Piezo-actuators can generate voltages by warming or cooling only (caused by the longitudinal change). The discharge potential should not be ignored due to the inner capacitance. This effect is insignificantly at usual room temperature.
- Piezo-actuators from **Newport Corporation** are adjusted and glued. Any opening of the unit will cause misalignment or possible malfunction and the guarantee will be lost.
- Please use only original parts from **Newport Corporation**.
- Please contact **Newport Corporation** or your local representative, if there are any problems with your actuator or power supply.

Caution!

Shock forces may damage the built-in ceramic elements. Please avoid such forces, and handle the units with care, otherwise the guarantee will be lost.

6 Safety Instructions

Icons:

European Union CE Mark



CE Mark

The presence of the CE Mark on New Focus equipment means that this instrument has been designed, tested and certified compliant to all applicable European Union (CE) regulations and recommendations.

Waste Electrical and Electronic Equipment (WEEE)



WEEE Directive Symbol

This symbol on the product or on its packaging indicates that this product must not be disposed with regular waste. Instead, it is the user responsibility to dispose of waste equipment according to the local laws. The separate collection and recycling of the waste equipment at the time of disposal will help to conserve natural resources and ensure that it is recycled in a manner that protects human health and the environment. For information about where the user can drop off the waste equipment for recycling, please contact your local Newport representative.

Control of Hazardous Substances



RoHS Compliant Symbol

This label indicates the products comply with the EU Directive 2011/65/EC that restricts the content of six hazardous chemicals.

 **RISK OF ELECTRIC SHOCK!** Indicates that a risk of electric shock is present and the associated warning should be observed.

 **CAUTION! REFER TO OPERATOR'S MANUAL** – Refer to your operator's manual for additional information, such as important operating and maintenance instructions.

RISK OF ELECTRIC SHOCK! 

- Do not open the units! There are no user serviceable parts inside and opening or removing covers may expose you to dangerous shock hazards or other risks. Refer all servicing to qualified service personnel.
- Do not spill any liquids into the cabinet or use the units near water.

CAUTION! 

- Allow adequate ventilation around the units so that heat can properly dissipate. Do not block ventilated openings or place the units near a radiator, oven or other heat sources. Do not put anything on top of the units except those that are designed for that purpose (e.g. actuators).
- Work with the units only in a clean and dry environment! Only specially prepared units (e.g. actuators) can work under other conditions!
- Please use only original parts from **Newport Corporation**.
- Newport Corporation does not give any warranty for damages or malfunction caused by additional parts not supplied by **Newport Corporation**. Additional cables or connectors will change the calibration and other specified data. This can change the specified properties of the units and cause them to malfunction.
- Do not place the units on a sloping or unstable cart, stand or table as they may fall or not work accurately.
- Piezo elements are sensitive systems capable of the highest positioning accuracy. They will demonstrate their excellent properties only if they are handled correctly! Please mount them properly only at the special mounting points.

Immediately unplug your unit from the wall outlet and refer servicing to qualified service personnel under the following conditions:

- when the power supply cord or plug is damaged
- if cleaning supplies or liquid has been spilled or objects have fallen into the unit
- if the unit has been exposed to rain or water
- if the unit has been dropped or the housing is damaged

6.1 Installation, Power Supply

RISK OF ELECTRIC SHOCK 

- Do not insert or unplug the power plug with wet hands, as this may result in electrical shock.
- Do not install in rooms, where inflammable substances are stored. If flammable substances come into contact with electrical parts inside, this may result in fire or electrical shock.
- Do not damage or modify the power cord. Also, do not place heavy objects on the power cord, or pull on or excessively bend it, as this could cause electrical damage and result in a fire or electrical shock.

- Always grasp the plug portion when unplugging the power plug. Pulling on the power cord may expose or snap the core wire, or otherwise damage the power cord. If the cord is damaged, this could cause an electricity leak and result in a fire or electrical shock.

CAUTION! 

- Do not use accessories other than the provided (e.g. power cord). Plug the power cord only in grounding equipment conductor power sockets.
- Do not place any heavy objects on any cables (e.g. power cords, sensor cables, actuator cables, optical cables).
- Do not block ventilated openings or place the units near a radiator, oven or other heat sources. Do not put anything on top of the units except those that are designed for that purposes (e.g. actuators).
- Plug the power cord completely in the grounding equipment conductor power sockets so that it cannot loosening inadvertently.
- Leave sufficient space around the power plug so that it can be unplugged easily. If objects are placed around the power plug, you will be unable to unplug it in an emergency.
- Install the system in that way that the on/off-switch is accessible without problems.

6.2 Operation

Please note the area with general safety precautions (see section 6ons”)

RISK OF ELECTRIC SHOCK! 

- Do not spill inflammable substances inside the voltage amplifier. If these items come into contact with an electrical component inside the voltage amplifier, this may result in a fire or electrical shock.

CAUTION! 

- If the voltage amplifier emits smoke, big heat or unusual smells, immediately turn off the power switch and unplug the power plug from the outlet. Then contact our technical service.

6.3 Maintenance and Inspection

CAUTION!

- When cleaning the exterior box of the voltage amplifier, first turn off the power switch and unplug the power plug. Failure to observe these items may result in a fire or electrical shock.
- Cleaning the exterior box using a firmly wrung-out cloth. Do not use alcohols, benzene, paint thinner or other inflammable substances. If flammable substances come into contact with an electrical component inside the voltage amplifier, this may result in a fire or electrical shock.

6.4 Environmental Conditions

The amplifier can be used:

- indoor
- altitude up to 2000 m
- temperature: 5 ... 35 °C
- relative humidity: 5 ... 95% (non-condensing)

The recommended environmental conditions are:

- indoor
- altitude up to 2000 m
- temperature: 20...22 °C
- relative humidity: 5 ... 80% (non-condensing)

7 NPC3, NPC3SG, NPC120 and NPC120SG

These voltage amplifiers are very similar. In case of information which do refer to the NPC3SG or NPC120SG the symbol “ → not available in NPC3, NPC120” will point it.

NPC3

Piezo amplifier for up to 3 PZT actuators; RS232/USB interface; for piezo actuating systems without feedback sensor inside, 40mA current per actuator

NPC3SG

Piezo amplifier for up to 3 PZT actuators; RS232/USB interface; for piezo actuating systems with feedback sensors inside (strain gauge), 40mA current per actuator

NPC120

Piezo amplifier for one PZT actuator; RS232/USB interface; for piezo actuating system without feedback sensor inside, 120mA current per actuator

NPC120SG

Piezo amplifier for one PZT actuator; RS232/USB interface; for piezo actuating system with feedback sensor inside (strain gauge), 120mA current per actuator

7.1 Keywords

GRAPHIC DISPLAY

Dimmable 3.5" TFT full colour graphic, 320x240 Pixel; constantly shows all values and status information

ENCODER KNOB

For manually voltage or position adjustment and for switching on/off the CLOSED LOOP mode (NPC3SG only)

CLOSED LOOP

Operating mode for piezo actuating systems with integrated feedback sensor system, position accuracy is constantly controlled

OPEN LOOP

Operating mode for actuating systems without feedback sensor inside; no position information available

MODULATION INPUT

The amplifier can be controlled by an applied analogue voltage signal from 0V...+10V (see 8.2.1)

MONITOR OUTPUT

Output voltage signal which corresponds with the position of the piezo actuating system (CLOSED LOOP mode) or with the applied voltage signal (OPEN LOOP mode), (see 8.2.2)

PC INTERFACE

Serial RS232 interface or USB1.1 (see 8.3)

REMOTE CONTROL

The remote control switches all manual controls (ENCODER KNOB and MODULATION) off or on. Please pay attention only if the remote control is switched on (1) it will be possible to use the "set" command.

HYPER TERMINAL PROGRAM

This software enables to control the piezo actuating system by using the RS232 interface. The available commands are described in chapter 8.3.2.

ASI function (Automatic Sensor Identification)

NPC3SG, NPC120SG amplifiers can be used with strain gauge feedback sensors. The **ASI** function makes it possible to show the name of the actuator and the measurement system.

Soft Start

Initialization after turning-on procedure. During initialization sequence the piezo electrical actuator is controlled for approximately 10 seconds with a voltage signal from -20V up to 130V. Please note: the actuating system is moving!

MAIN SUPPLY VOLTAGE

The main supply voltage to the amplifier is 24VDC; an external wide range power supply is included in the shipment

7.2 User Elements / Connections

7.2.1 Front Panel

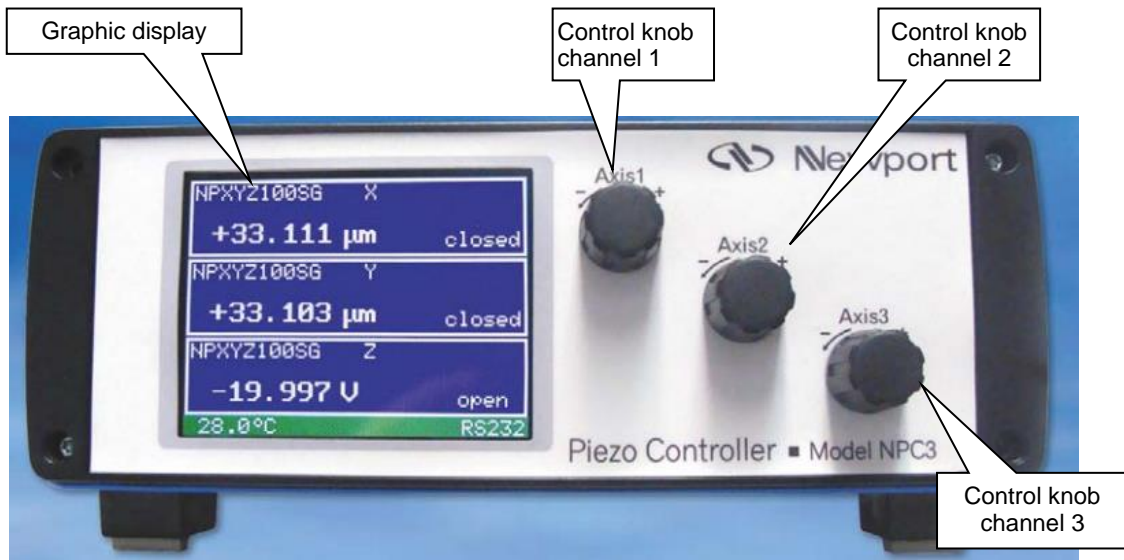

7.2.2 Back Panel

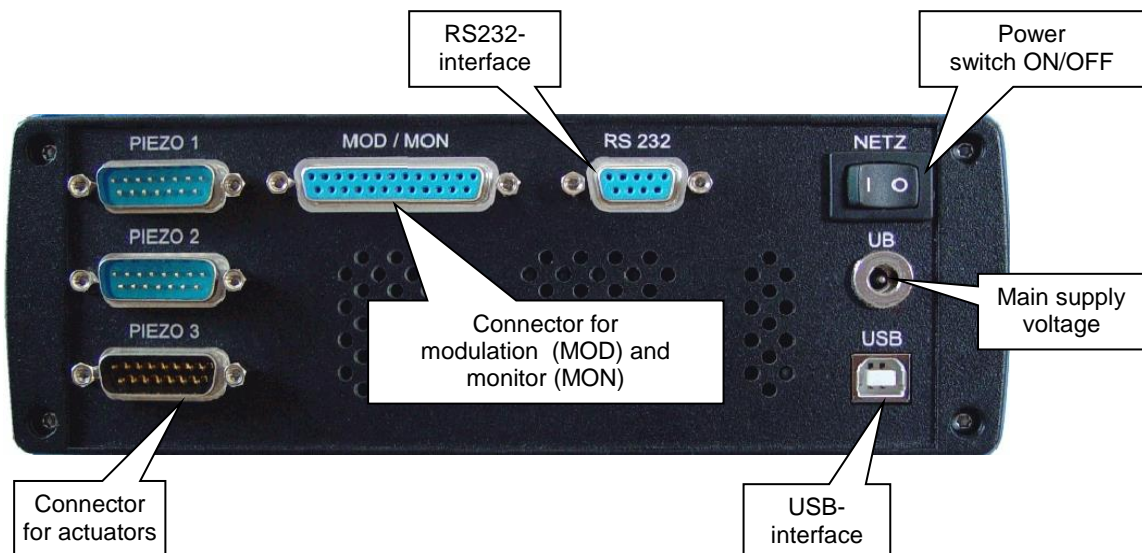

7.3 Introduction

The amplifiers NPC3 and NPC3SG are designed for parallel control of up to three low voltage piezo actuators with and without internal feedback sensor system. NPC120 and NPC120SG are designed for control of one low voltage piezo actuators with higher output current. The amplifiers come as a stand-alone device with standard PC interface RS232 and USB. A dimmable graphic display constantly shows all status information such as voltage and motion.

Each piezo can be controlled separately by turning the voltage offset, by applying an analog voltage signal of 0 to 10V or by PC interface. The voltage of the monitor output corresponds to either applied piezo voltage (NPC3, NPC120) or completed motion (NPC3SG, NPC120SG).

The NPC3 and NPC120 are designed for controlling only open loop actuating systems without any feedback sensor inside. The NPC3SG and NPC120SG are designed for piezo actuating system with strain gauge feedback sensors inside. In this case, the sensor signal is prepared by an external pre-amplifier inside the cable. The Automatic Sensor Identification "ASI" enables the customer to use the amplifier NPC3SG or NPC120SG with different piezo actuators of the same product series. This enables the controller unit to read all system information from the actuating systems which are stored inside the connector and transmit this information to the amplifier unit.

The chart 7.3.1 shows the block diagram of the NPC120SG. With exception of the display and the processor, the circuit is triplicate for the NPC3SG series. The series NPC3 and NPC120 don't have a PID-Controller, an ADC for measurement signals and the switch for the monitor signal.

7.3.1 Block Diagram

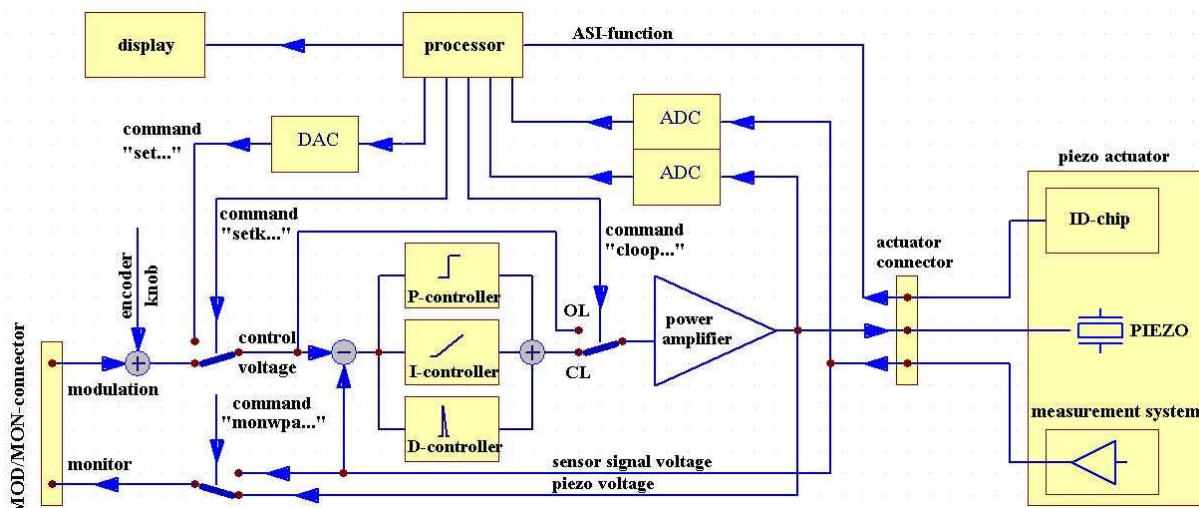

Block Diagram NPC120SG, (NPC3SG would be in triplicate and non-SG versions do not have PID, ADC nor monitor switch)

7.3.2 Amplifier with integrated feedback controller

Analog actuating systems with integrated feedback sensors are calibrated with a particular amplifier unit. Only systems consisting of piezo and amplifier which are calibrated to each other can be used together to reach the full accuracy performance. Exchanging of actuating system is possible in this case only if the actuating system is from the same product group. Otherwise the closed loop controller can be damaged!

Example: If the amplifier NPC3SG is calibrated for a 3-axis system NPO140SG (range of motion 140 μ m), then it can be used with different NPO140SG actuators, but not with NPO250SG (range of motion 250 μ m). Different actuators have different resonant frequencies and the PID controller have other calibrations. If an actuator is connected to a channel of the amplifier NPC3SG which it was not calibrated with, it won't be possible using in closed loop.

Please note that the information about the operation mode (closed loop, open loop) are automatically stored if the system is switched off. When it is switched on again, the last operation mode is set again. The system starts automatically at the zero position.

7.3.3 Amplifier without integrated feedback controller

Any system delivered as open loop mode cannot be modified to closed loop later on. Any closed loop system can be easily calibrated to a different closed loop piezo afterwards. This is only possible at **Newport Corporation** and will cause additional effort and costs. Please contact our sales team for more information.

7.4 Initiation

Please follow all safety instruction given in chapter 6 before using the amplifier.

7.4.1 Main Supply Voltage

The amplifier NPC3, NPC3SG, NPC120 and NPC120SG require a main supply voltage of 24VDC. A power supply unit suitable for voltages from 100 up to 240Volt AC is included in the shipment. The socket for the main supply voltage is located on the back panel of the amplifier.

7.4.2 Connecting Piezo Actuator

Piezo electrical actuators are connected to the amplifier unit by using the D-SUB connector on the back panel. Please make sure that the amplifier is switched off when connecting / disconnecting the PZT to the amplifier. Please fasten the screws of the D-SUB connector and guarantee a firm connection. After switching on the initialization procedure follows. (please see chapter 7.1) Then the display shows the details of the used PZT.

If the display shows the information "NOT CONNECTED" please check the connection between PZT connector and amplifier again. Please note: during initialization procedure the operation of the unit is disabled.

7.4.3 Graphic display NPC3, NPC3SG

The graphic display shows the following status information:

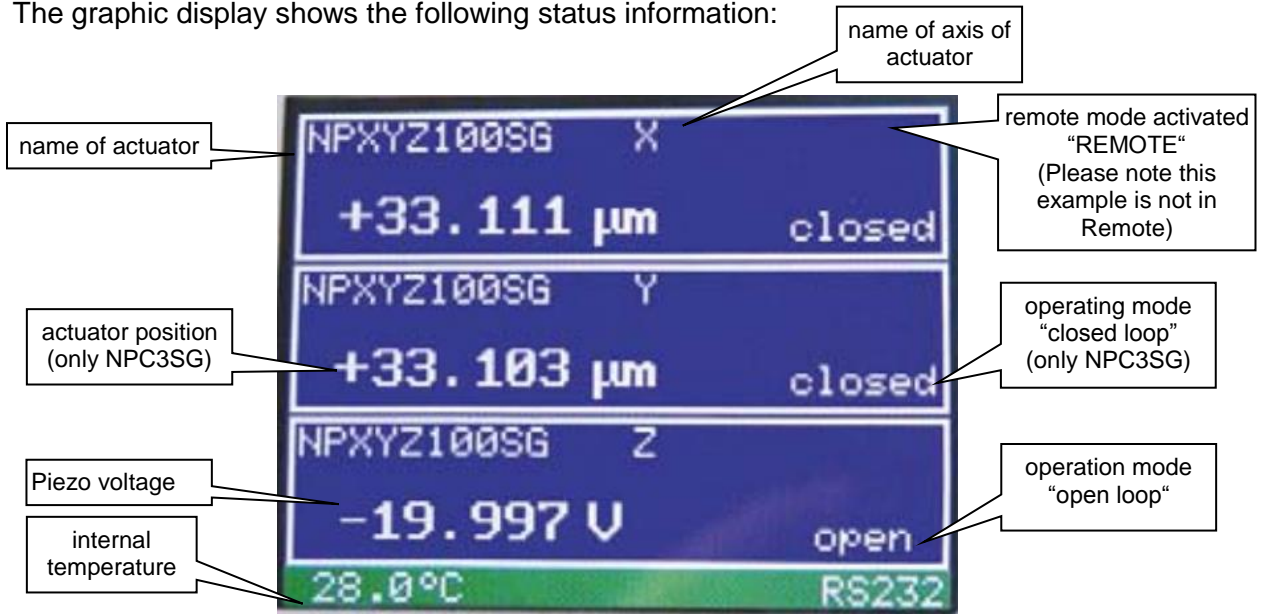

7.4.4 Graphic Display NPC120, NPC120SG

The graphic display shows the same status information as the NPC3, NPC3SG but only for one channel.

8 Handling

8.1 Manual Control

Each channel can be controlled by turning the encoder knob on the front panel. Turning clockwise increases the applied voltage signal, turning counter clockwise reduces the applied voltage signal. Depend on how fast the knob is turned, the change of the applied signal can be adjusted.

The closed loop mode of the NPC3SG, NPC120SG amplifier can be switched on and off by pressing the encoder knob for each channel. If you switch off the amplifier the operational mode (closed loop, open loop) will be saved, and after switching on, the amplifier starts again with its last operational mode.

8.2 Controlling via Modulation / Monitor

8.2.1 Modulation

The amplifier can be controlled by an external modulation signal from 0 to 10V. In addition, the digital encoder can be used to shift the offset of the modulation input. Please note, the signal of the encoder and the signal of the modulation input are added finally. The sum of both voltages must be in range between 0 and 10 Volts. Voltages outside of the permissible field are signalled by UDL or OVL.

An adapter cable with BNC to D-SUB connector is included. The modulation is marked on the back panel by MOD/MON.

By using an external modulation signal in open loop mode 0V correspond to a value of -20V and 10V correspond to voltages signal of 130V applied to the piezo actuating system.

In closed loop mode (☺) 0V corresponds to a motion of 0 μ m, 10V corresponds to the max. motion based on the specification of the used piezo actuating system.

8.2.2 Monitor NPC3SG, NPC120SG

The monitor output is an analogue feedback of the output parameters. The monitored value based on a scaled value from 0 to +10 and in addition the reserve value of the overshooting range.

The monitor output can be switch in different modes via RS232 or USB interface.

(x describes the number of channel)

monwpa,x,0: Output of a voltage proportional to the actuator voltage. This mode will set the monitor output signal fixed to its characteristics. Shown in diagram 1.

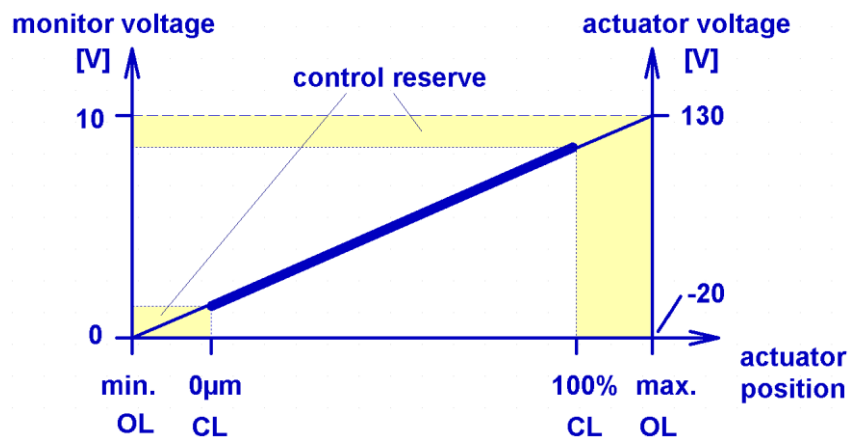
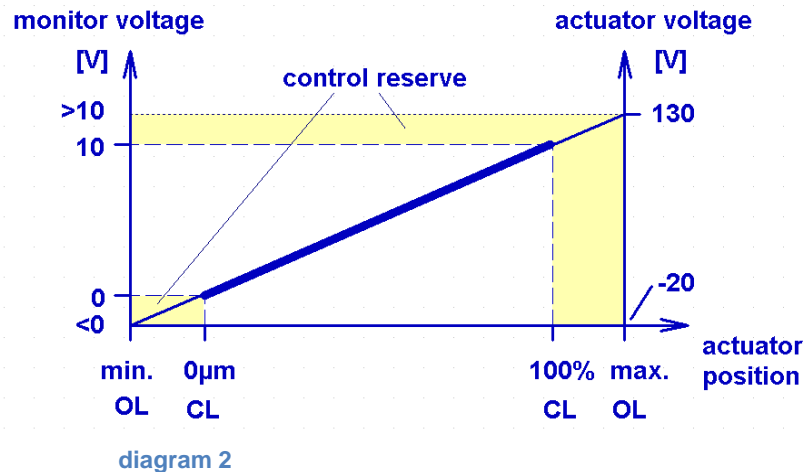

diagram 1

Based on this a signal of 0V is related to an applied voltage of -20V and +10V is related to +130V. In closed loop the minimum and maximum values never reaches caused by the closed loop control reserve.

monwpa,x,1: Output of a voltage proportional to the actuator position (delivery status). Shown in diagram 2.



The monitor output provides a voltage signal which corresponds directly to the position of the piezo actuating system (delivery status). The value of the monitor output voltage range is from 0V to +10V in closed loop mode and from -13V to +13V in open loop mode (minimum and maximum depends of motion range).

monwpa,x,2: In open loop the monitor provides a voltage signal of 0V up to +10V which corresponds to the voltage signal applied to the piezo actuator. The monitor output follows the characteristic curve shown in diagram 1. In closed loop the monitor output provides a voltage signal which corresponds directly to the position of the piezo actuating system. Shown in diagram 2.

For amplifiers with “closed loop” operation (“SG” version) in combination with open loop actuating systems, the monitor output shows a voltage signal proportional to the applied piezo actuator control signal. The command “monwpa” is deactivated.

8.2.3 Monitor NPC3, NPC120

The monitor output of the NPC3, NPC120 always provides a signal of 0V up to +10V which directly corresponds to the voltage signal applied to the piezo actuator. The command „monwpa“ is deactivated.

8.3 Controlling via Interface

The amplifier series NPC and NPCSG can be controlled via RS232 interface. Therefore signal parameters and information about the actuator position or status can be adjusted or settled directly. Furthermore, the system settings of the amplifier unit can be changed by using the interface. A fully PC controlled piezo system for automation purposes is feasible. Please connect the amplifier system by using the RS232 or the USB interface with your PC. During this the piezo amplifier must be switched off!

For using the interface a simple Terminal-Program can be used. Please note that the program “WINDOWS-HyperTerminal” isn’t a part of Microsoft® WINDOWS since

WINDOWS–VISTA is launched. By using the USB interface, please install the necessary driver which is supplied on a CD-Rom with the amplifier unit.

The supplied VI-driver is used for the integration of the amplifier systems into an existing Lab-View® program or for programming of a new program. As a part of the supplied software package software for controlling of the amplifier units is included or can be downloaded from our web site as well.

8.3.1 Configuration RS232

For external control by PC interface RS232 the following settings are necessary:

Baud rate / Bits per second	19200
Data bits	8
Stop bits	1
Parity	no
Flow control	Software (XON / XOFF)

chart 1: configuration RS232

8.3.2 Command List Overview

command	content
s	shows all available commands
setk	switches the remote control for one channel on or off
cloop	switches one channel to closed loop or open loop (⚙)
set	sets the values to one channel
setall	sets the values to all channels
rk	measures either the position (only NPC3SG, NPC120SG) or voltage (only NPC3, NPC120) only for one channel
measure	gives values of all channels either for position (⚙) or voltage
monwpa	switches the monitor in different modes
fenable	enables the soft start function for the given channel
fready	enables the soft start function for all channels
encmode	encoder: mode (EN)
enctime	encoder: sample interval (SI)
enclim	encoder: maximum step
encexp	encoder: exponent for calculation of acceleration (EM0)
encstol	encoder: interval for "open loop" (EM1,2)
encstcl	encoder: interval for "closed loop" (EM1,2) (⚙)
ver	gives the version number of controller and amplifier software
ERR?	shows the last occurred error
light	display brightness

chart 2: command list overview

NPC3, NPC3SG:

The numbers for the channels starts with „0“. Connector "PIEZO 1" equals channel number "0". The format of the command is: <command>,<channel>,<value>

NPC120, NPC120SG:

Set command is without channel number. The format of the command is: <command>,<value>

Please use dot “.” if commands included a value to separate decimal places.

8.3.3 Commands

command 'setk'

call: setk,<ch>,<0|1>

example: setk,0,1

answer: none

set the actuator on channel 0 (PIEZO 1) to remote control

The command setk switches the remote control for one channel <ch> on <1> or off <0>. If the remote control is activated you won't be able to change the position neither by the ENCODER KNOB nor via MODULATION. With the command setk,<ch>,1 the pre-settled encoder value is taken over. If the remote control is switched off by the command <0>, the pre-settled value, command set or setall is taken over into the analogue control.

Turning the remote control off, the position of the actuator goes to minimal position.

command 'cloop' (⚡)

call: cloop,<ch>,<0|1>

example: cloop,1,0

answer: none

Channel 1 (PIEZO 2) is set to the operation modus open loop

The command “cloop” switches channel of the amplifier (⚡) to the operation mode closed loop <1> or to open loop <0>. Command without value reads out the current value.

command 'set'

call: set,<ch>,<wert>

example: set,0,5.53

answer: none

set the position of the actuator to the given value. In closed loop (⚡) the value is 5.53 µm. In open loop the value means 5.53 V

The command “set” sets a channel <ch> to the given value <value>. In closed loop (⚡) the value means µm. In open loop the value means the voltage which is applied to the actuator. Please pay attention that the remote control has been switched on before.

command 'setall'

call: setall,<value0>,< value 1>,< value 2>

example: setall,22,1.5,5.53

answer: none

sets the position of the actuator to the given value <value0, 1, 2>, for instance PIEZO1 to 22, PIEZO 2 to 1.5 and PIEZO 3 to 5.53

The command “setall” sets all channels to the given values <value>. In closed loop (⚡) the value <value0, 1, 2> means µm. In open loop the value <value0, 1, 2> means the voltage which is applied to the actuator. Please take care that the remote control for all channels has to be switched on.

command 'rk'

call: rk,<ch>

example: rk,1

answer: rk,<ch>,<value>

rk,1,20.016

**That means for
 open loop: 20.016V
 closed loop: 20.016µm (⚡)**

The command „rk“ reads out either the position value for one channel <ch> from the measuring system in closed loop (⚡) or the voltage applied to the actuator in open loop. The readout value is given with 3 decimal places.

command 'measure'

call: measure example: measure
answer: aw,<value0>,<value1>,<value2> **aw,0.015,5.003,150.002**

The command „measure“ reads out either the position <value0, 1, 2> from the measuring system in closed loop (⚡) or the voltage applied to the actuator in open loop. The readout values <value0, 1, 2> are given with 3 decimal places.

command 'monwpa'

call: monwpa,<ch>,<0|1|2> example: monwpa,0,1
answer: none **switches the monitor signal on channel 0 to the position of the piezo actuating system**

modes: 0 = always actuator voltage
 1 = always voltage to the position of the piezo actuating system (⚡)
 2 = ol = actuator voltage, cl = measuring system voltage (⚡)

Command without value reads out the current value.

command 'ver'

call: ver example: ver
answer: version,vnumber,vdate **ver,1.000.799
 sdate,11/09/2006
 serno,23579**

This command “ver” reads out the software version number of the internal controller, the date and the serial number of the amplifier.

command 'ERR?'

call: ERR? example: ERR?
answer: ERROR,<“last error“> **ERROR,"OK. No error."**

The command “ERR?” gives the last failure from the controller. After read out the error from the controller the failure status in the memory will be deleted. The output of the error message occurs as plain text.

command 'fready'

call: fready,<0|1> example: fready,1
answer: none **the soft start is switched on for all channels**

This command 'fready' enables the soft start function for all channels. After switching on the system the soft start function is started for 10 seconds to initiate the actuator. While this routine the actuator is moved once through the whole motion range and back. During soft start the modulation input and the encoder are disabled. After soft start the amplifier is working normally. Command without value reads out the current value.

command 'fenable'

call: fenable,<ch>,<0|1>

example: fenable,0,1

answer: none

the soft start function is switched on for the channel 0 (PIEZO 1)

This command 'fenable' enables the soft start function for the given channel. After switching on the system the soft start function is started for 10 seconds to initiate the actuator. While this routine the actuator is moved once through the whole motion range and back. During soft start the modulation input and the encoder are disabled. After soft start the amplifier is working normally. Command without value reads out the current value.

command 'light'

call: light,<0...255>

example: light,0

answer: none

switch off the display

The command „light“ can be used to control the brightness of the display. Adjustable values are between “0” (display off) and “255” maximum brightness. The last adjustment will be stored and will be automatically used if the amplifier will be switched on. Command without value reads out the current value.

Please pay attention! If the display remains dark after switching on the amplifier the display may have been adjusted to “light,0” before. Please read out the value by input command “light” and change the value if necessary.

8.3.4 examples

example 1:

This example shows the sequence of the commands to move the actuator on channel 0 with the NPC3SG from the minimal position 0 µm to 10µm, channel 1 is set in open loop to 90Volts and channel 2 is set to closed loop to position 20.5µm:

command	response	content
[Enter]	NPC3SG> (NPC3, NPC120SG, NPC120)	after pressing the [Enter] key on the computer keyboard the prompt shows “NPC3SG>” (NPC3, NPC120SG, NPC120) in the HYPER TERMINAL program
setk,0,1	none	activates the remote control on channel 0
cloop,0,1	none	switches channel 0 to closed loop mode
set,0,10	none	set channel 0 to 10µm
setk,1,1	none	activates the remote control on channel 1
cloop,1,0	none	switches channel 1 to open loop mode
set,1,90	none	set channel 1 to 90Volts
setk,2,1	none	activates the remote control on channel 2
cloop,2,1	none	switches channel 2 to closed loop mode
set,2,20.5	none	set channel 2 to 20.5µm
measure	aw,10.000,90.000,20.500	displays the set values

chart 3: example for remote control NPC3SG

example 2:

This example shows the sequence of the commands to move the actuator with the NPC120 from the minimal position 0µm to 35,46µm:

command	response	content
[Enter]	NPC120SG	after pressing the [Enter] key on the computer keyboard the prompt shows "NPC120SG>" in the HYPER TERMINAL program
setk,1	none	activates the remote control
cloop,1	none	switches to closed loop mode
set,35.46	none	set the actuator to 35.46µm
rk	rk,35.460	displays the set value

chart 4: example for remote control NPC120[SG]

8.3.5 Calibration of Encoder

The encoder of NPC3 [SG] e.g. NPC120 [SG] is used for the calibration of the attached actuator in open and closed loop. The encoder has a resolution of 30 detent / rotation. With each step of the encoder an internal counter (**EncIncr**) within the scanning interval (**SI**), will be incremented or decremented, depending on the direction of rotation. After scanning interval the NPC3[SG] calculates a new stroke (⚡) or voltage (**deltaValue**), depending on the mode (**EM**). The actuator will be charged with this calculated value. **EncIncr** will be clear the encoder and the procedure start again.

The values of the encoder can be analyzed by 3 different modes (**EM**):

- normal with acceleration (**EM0**) calculation deltaValue:
deltaValue = EncIncr^{EncExponent}
- adjustable interval (**EM1**) calculation deltaValue:
deltaValue = EncStep
- adjustable interval with acceleration (**EM2**) calculation deltaValue:
deltaValue = EncIncr * EncStep

encoder commands generally:

call: encmode,<0 to 2> example: encmode,1
answer: none **the mode of encoders is set to EM1 (adjustable interval)**

call: enctime,<0 to 255> example: enctime,2
answer: none **scanning interval (SI) is set to 0.04 sec**

Scanning interval (**SI**) can be adjusted in a range between 0 and 5.1sec with a step size of 0.02 sec. The evaluation of the encoder will be done in this time period. In each interval only one encoder can be evaluated! This means, if you have 3 active channels and an adjusted interval of 1 sec. the encoder will be scanned in an interval of 3 seconds.

call: enclim,<1...65535> example: enclim,10000
answer: none **the step limitation is set to 10000**

If the absolute value of **deltaValue** is higher than enclim, **deltaValue** will set to enclim with the same prefix.

The above-named commands are valid for all modes.

special commands for encoder:

- normal with acceleration (**EM0**)

call: encexp,<1...10>

example: encexp,3

answer: none**the exponent is set to 3**

- adjustable interval with and without acceleration (**EM1,2**)

call: encstol,<0.001...150.000>

example:encstol,1.000

answer: none**the step size for „open loop“ is set to 1V**

The numerical resolution of 1mV will be not achieved due to the resolution of the DAC of 16 bit. The real step size is approximately 3mV

call: encstcl,<0.001...100.000>(⚡)

example:encstcl,0.001

answer: none**the step size for „closed loop“ is set to 1nm**

8.4 Technical Data

	NPC3 [SG]	NPC120 [SG]
number of channels	3	1
output power	3x 5W	15W
output voltage	-20V to +130V	
output current (continuous)	3x 40mA	120mA
noise of output voltage	<0,3mV _{RMS} @ 500 Hz	
modulation input (MOD)	0V to +10V, D-SUB25pin	
input impedance	10 kΩ	
manually control	digital encoder	
display	TFT full colour graphic, 320x240 Pixel	
output connector	3x D-SUB15pin	D-SUB15pin
monitor output (MON) NPC3SG, NPC120SG selectable	D-SUB25pin, output impedance <100Ω -13 to +13V measuring system voltage (open loop) 0 to +10V measuring system voltage (closed loop)	
monitor output (MON) NPC3, NPC120	D-SUB25pin, output impedance <100Ω 0 to +10V (equates to actuator voltage -20 to +130V)	
closed loop control (☺)	PID analogue, switched on/off by pushing the encoder knob, for SG sensors	
dimensions w x h x l	210mm x 88mm x 240mm	
mass	2,1kg	
interface	RS232 D-SUB9pin, USB 1.1	
converter resolution	16 bit	
features	soft start function, ASI function, over voltage protection, over temperature protection, short circuit proof, dimnable display	
main power supply	24VDC / 2,5A (wide range power supply 100-240VAC is included in the shipment)	
order info	NPC3 NPC3SG NPC120 NPC120SG	

Chart 5: Technical Data NPC3 [SG], NPC120 [SG]

8.5 Pin Assignment

8.5.1 Output Connector for Actuator D-SUB 15pin

The D-SUB 15 connector for the piezo actuating system has two functionalities. First, connection for the voltage signal of the piezo control, and second, the voltage supply for the feedback sensors, when a closed loop system is used. In addition, the calibration data of the feedback system, stored on an ID-Chip on the actuator side, are forwarded to the amplifier.

8.5.2 MOD/MON connector D-SUB 25pin

The MOD/MON connector on the backside is used for modulation and for monitoring. With the modulation an analogue signal is served to the amplifier. The monitor shows the response of the system also as an analogue signal.

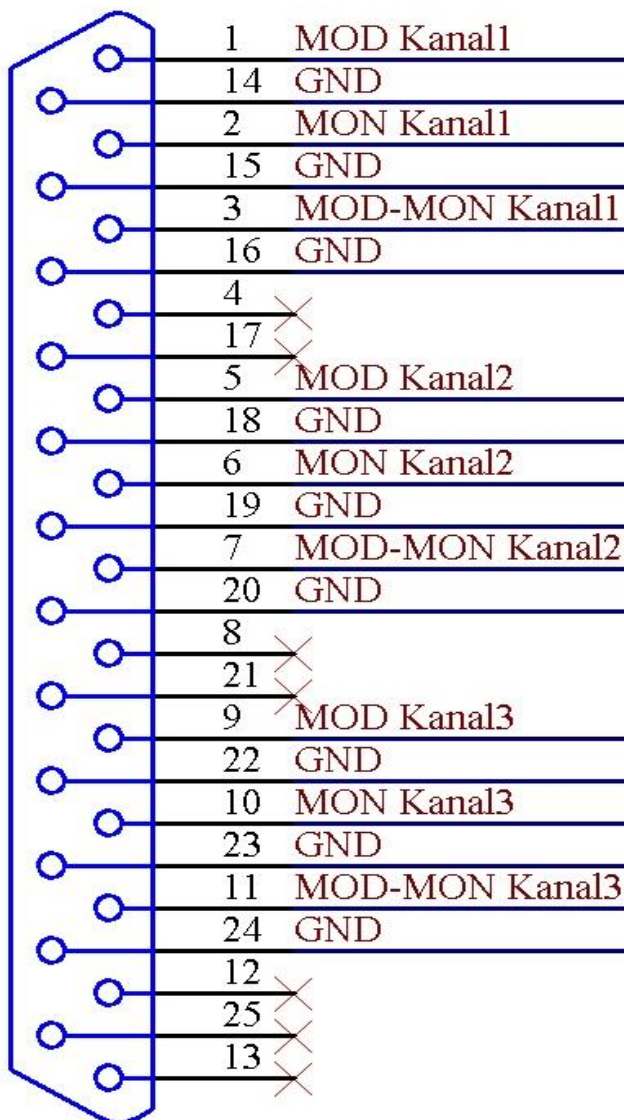

pin	description
1	modulation channel 1
14	Ground
2	monitor channel 1
15	Ground
3	MOD-MON difference channel 1
16	Ground
4	n.c.
17	n.c.
5	modulation channel 2
18	Ground
6	monitor channel 2
19	Ground
7	MOD-MON difference channel 2
20	Ground
8	n.c.
21	n.c.
9	modulation channel 3
22	Ground
10	monitor channel 3
23	Ground
11	MOD-MON difference channel 3
24	Ground
12	n.c.
25	n.c.
13	n.c.

chart 7: MOD/MON connector NPC3SG
 (for NPC120SG please use channel 3)

The MOD/MON adapter cable is part of the delivery. If the use of a self-made adapter cable necessary, no liability for the functionality and the system parameters can be guaranteed. Please contact **Newport Corporation** for detailed information.

8.5.3 RS232 D-SUB 9pin

pin	description	explanation
2	TxD	RS232 transmitter
3	RxD	RS232 receiver
5	GND	RS232 Ground
4,6		Bridge
7,8		Bridge

Chart 8: RS232-connector NPC3[SG], NPC120[SG]

8.5.4 USB 1.1

pin	description	explanation
1	VCC	supply voltage +5V
2	D-	Data -
3	D+	Data +
4	GND	Main power supply ground

Chart 9: USB-connector NPC3[SG], NPC120[SG]

8.5.5 Main Supply Voltage

The NPC3, NPC3SG, NPC120 and NPC120SG needs 24VDC and require at least a current of 2.5A. The 2.1mm barrel connector has the following layout. A wide range power supply 100-240VAC is included in the shipment.

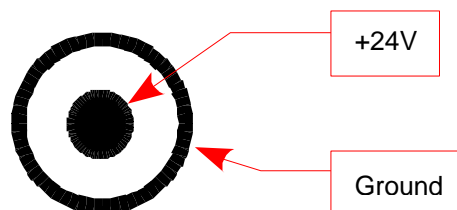

9 Troubleshooting

During operation the display can show a defined error code. A reason can be the buffer overflowing, a temperature value out of range or a overshooting of the actuating system. Promptly the error code is provided on the display and on the connected PC too. The code is 16bit wide and it's binary-coded (*ERROR,FWch0,FWch1,FWch2*). The code is based on follow:

bit	description
0	actuator not connected
1	actuator with shorten circuit
12	out of range downwards
13	out range overshooting
14	wrong actuator type
15	temperature out of range
2,3,4,5,6,7,8,9,10,11	not used

chart 10: error code

Some possible errors and their corrections are listed in the following table:

error	possible error correction
function after switching on	Please check the main voltage supply and all connections. Please check the position of the main power switch on the back side. Please check if the main power module plugged in (indicated by a LED)
display shows: „not connected“	Please check if the actuator is plugged in and the connector fixed by the screws correctly. Please check all cables and connectors for any damage.
The UDL or OVL sign flashes during open loop mode	Check the value of the Offset. High modulating voltage overdrives the amplifier. Switch off the modulation or reduce the modulation voltage until sign is off.
The UDL or OVL sign flashes during closed loop mode	Buffer overflow: please check the status of the actuating system. The system must be able to move over the entire travel range without limitation. Also an mechanically overloaded system can cause this error code. For more information about the max. load, please check the calibration information provided with the actuating system.
actuating system is oscillating during operation	The resonant mode of actuating system is reached. The calibration data needs to be adjusted according to the load or control function. Reducing of the applied load.

chart 11: possible error correction

10 Your Notes