

High Performance Air Bearing Stage Capabilities & Solutions



50 years of proven performance, expertise and experience

For Motion, Think Newport

 **Newport**
Experience | Solutions

Table of Contents

<p>About Us 2</p> <p>OEM – Developing for the Future 3</p> <p>Overview of Air Bearing Products 4</p> <p>DynamYX® - Family of Stages for Semiconductor Wafer Processing and Inspection 5</p> <p style="padding-left: 20px;">Introduction/Selection guide 6</p> <p style="padding-left: 20px;">Model Presentation 7</p> <p style="padding-left: 20px;">Spec Table 9</p> <p style="padding-left: 20px;">Open Frame Capability 10</p> <p>HybrYX® – High-Performance Solutions for Semiconductor Wafer inspection, Flat Panel, PCB and Photovoltaic Applications</p> <p style="padding-left: 20px;">Introduction/Selection guide..... 11</p>	<p>Model Presentation 13</p> <p>Spec Table 14</p> <p>SinguLYS™ - Dedicated single axis air bearing stage and bridge designs for scanning applications 15</p> <p style="padding-left: 20px;">Introduction/Selection guide..... 15</p> <p style="padding-left: 20px;">Model Presentation 16</p> <p style="padding-left: 20px;">Spec Table 17</p> <p>ZT3 z tip tilt theta with active plane technology 18</p> <p>Newport's Differentiating Design Philosophy 19</p> <p>Capabilities in Advanced Ceramic Materials 22</p> <p>Air Bearing System Options and Accessories 23</p> <p>Newport Resource® 24</p>
--	--

About us

Newport Corporation is a globally recognized leader in advanced technology products and solutions for fields such as Research, Life and Health Science, Aerospace and Defense, Industrial Manufacturing, Semiconductors and Microelectronics.

From systems design through manufacture to onsite installation, Newport's motion's team is fully autonomous and focused on developing high precision systems matching optimally your individual needs. Our team has a combined experience of high precision, multi axis motion component design and manufacture spanning half a millennium. We offer a comprehensive understanding of customer's needs, through applications engineering, design, project management, manufacturing to customer operation excellence (Sales, CSR, Operation and Service).

We have in excess of 1000 field deployed tools installed in facilities around the world, many operating in 24/7 environments in the semiconductor industry in wafer inspection and lithography applications, for example. Other applications include flat panel display (FPD) inspection and processing and laser scribing of thin-film photovoltaic panels & various laser scribing applications related to LED manufacturing.

Marketing-Leading Systems Solutions

Markets

Newport's custom systems serve a comprehensive range of markets

- Industrial Metrology & Manufacturing
- Aerospace & Defense
- Research
- Semiconductor & Microelectronics
- Life & Health Sciences

Applications

Call us for your systems requirements

- Positioning
- Test
- Metrology
- Inspections
- Manufacturing
- Advanced Packaging
- Laser Processing & High Load Actuators
- Micromachining

Technologies

Newport's motion product offering includes many high precision technologies

- Linear Stages
- Rotary Stages
- Goniometric Stages
- High load Actuators
- DC/Stepper/Piezo and Linear Motors
- Integrated Motion Controller to 8 axis
- Material Preparation
- Vacuum Preparation
- Ceramic Structure (SiC)



OEM – Developing for the Future

Our dedicated OEM group focuses solely on the unique requirements of OEM customers. This experienced, professional department was developed as a small worldwide group within a large company – hence, you get the best of both worlds. Draw upon the resources that a large company offers and get the individualized service and rapid response of a small company.

Your Project Matters

Our OEM strategy is to offer our customers a competitive advantage in their marketplace by providing direct access to our expert resources – engineering, manufacturing, logistics, and service organizations. We thoroughly evaluate a product, subassembly or sub-system from every angle to perform a rapid and in-depth feasibility review. During this initial assessment process, we determine the value we add based on our core technologies and competencies. We are with you every step of the way, with a team consisting of engineering, manufacturing, logistics, marketing and customer service for maximum support. We view this team as an integral part of your organization that reports directly to your project team.

Discretion at All Times

Your program's confidentiality is imperative and we make special provisions to ensure that the highest levels of confidentiality are maintained. Non-disclosure agreements are signed up-front before we begin technical discussions and design ownership issues are firmly established. Upon request, Newport will dedicate work cells for your application to ensure total confidentiality within our company for your own peace of mind.

Full Design and Manufacturing Control

Newport's OEM project leaders use a controlled procedure to manage your project. Complete BOMs are developed and controlled through our formalized ECO process with all assembly and test procedures fully and formally documented.

Our reputation as the leading OEM motion supplier is hard-earned. Our product performance, cost, delivery, and quality directly impacts your competitiveness – and that is why we get it right the first time!

The Optimum in Quality Control

Newport operates under the ISO 9001 registered quality system. As a result, our exemplary quality system is audited by a third party. As a further measure of our commitment to quality, we perform internal audits routinely to ensure we are compliant with our procedures. At Newport, we ensure that quality is built into the process and monitor quality through closed loop performance metrics.

Your Foundation of Support

Newport has a global infrastructure to ensure that after sales service and support extends on-site, at your facility or your customers facility. Our ability to solve your problems has no borders or time restrictions. Cooperative service agreements and extended warranties for specific support levels are available. Our factory-trained technicians bring test equipment and spare parts on-site to service our systems. Metrics can be established to track your product's service history.

We Put It Right

Should things not go according to plan, Newport has put in place closed loop corrective action systems. Complaints are entered into our customer management database and made directly accessible to our executive staff. This information is then reviewed for immediate corrective action. Once the root cause and course of corrective action has been determined, this information is provided to you in writing.

Overview of Air Bearing Products

Newport's reputation for being the premier supplier of high-precision motorized stages is exemplified by our full line of Air Bearing Positioning Systems. Whether you select the DynamYX® Datum™ capable of 5 G acceleration and nanometer accuracy, the evolutionary HybrYX® air and mechanical bearing “hybrid” stage or the newly released SinguLYS® that combined a lot of the advanced features of the previous models into a single axis solution, Newport has the knowledge and expertise needed to address the most complex and demanding motion control applications.

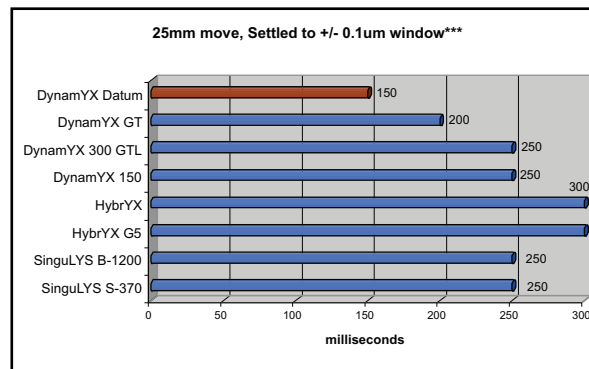
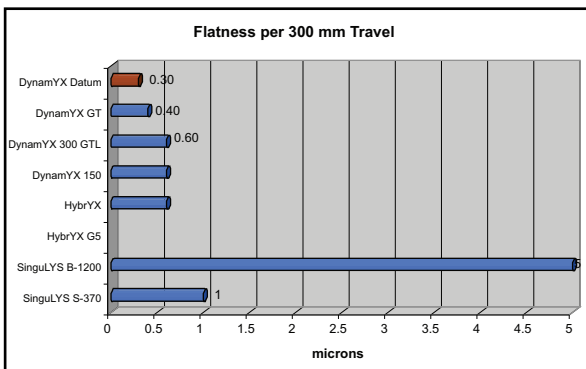
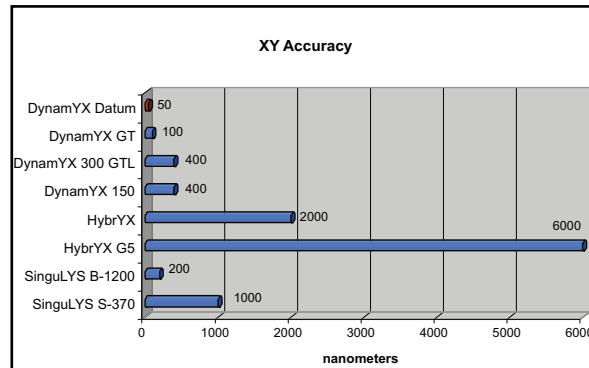
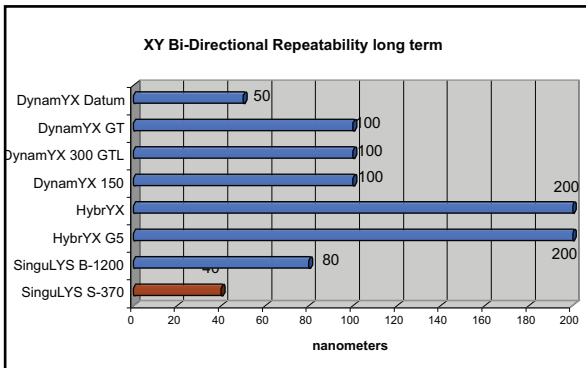
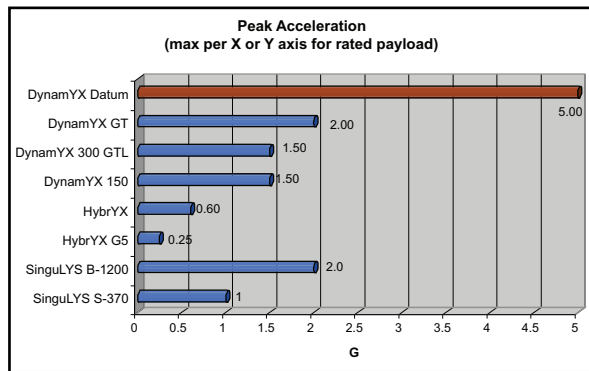
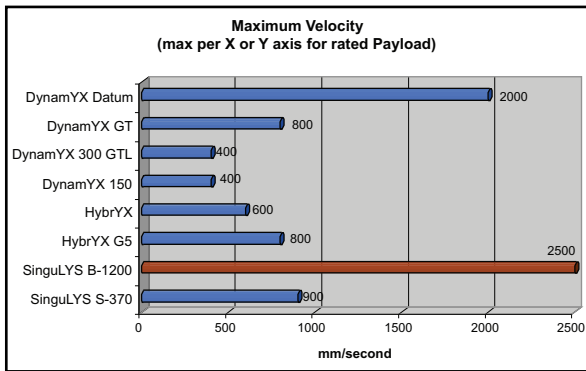

DynamYX[®] Family of Stages for Semiconductor Wafer Processing and Inspection

With the launch of the 300mm wafer initiative more than a decade ago, DynamYX was designed to provide equipment manufacturers in the semiconductor industry with a tool capable of achieving the highest levels of precision and throughput. DynamYX provides high resolution dynamic positioning of a wafer chuck or other similar substrate in two orthogonal translation axes from a single-plane carriage. A Vertical (Z) axis with Tip Tilt function and a rotary axis for wafer offset correction may be added on the carriage beneath the wafer chuck. Over the years, the form and function of DynamYX has evolved to keep pace with customer requirements. Today The DynamYX family consists of five specific designs each with their own specific features and benefits.

Position Feedback

The positioning loop on DynamYX may be closed using a single linear encoder for each axis. The encoder measuring positions are closely located to the substrate's surface reducing the already minimal abbey offset affect. For the X-axis, the linear scale is typically mounted to the underside of the bridge structure with the read-head in-line with the system's optical path and affixed to the moving ceramic guide. System architectures that do not allow this configuration can be accommodated by mounting the X-axis scale to a supplementary SiC spar located at the rear side of the system. The Y-axis has its scale mounted to a small SiC bracket on the moving carriage. The read head is fixed to the arm of the L-shape structure. Read-heads which have fixed positions relative to the tool's optical path are beneficial in optimizing precision. With an encoder signal period of 2 μ m, resolutions down to 0.1nm are possible with Newport's XPS or SPS controllers each with internal 20,000 times interpolation.

Equipped with linear encoders the DynamYX is an extremely accurate and very repeatable platform allowing for very high accuracy through error mapping. The geometric stability of the ceramic elements of these stages results in systems that can be mapped once at our factory then, upon installation, only require a simple length calibration to compensate for uniform thermal expansion. For applications where the accuracy requirements exceed the capabilities of error compensation, or in certain scanning modes where the absolute position of the stage must be the basis of a very precise trigger or latch, linear encoders must yield to laser interferometers which are also part of our offering.

Chuck Interface

The standard mounting interface includes three precision-lapped pads for the direct mounting of a wafer chuck. In the DynamYX 300 and GT stages, these three pads are only 66mm above the granite reference plane maintaining the low-profile nature of the stage. Even with the addition of other accessory components such as a 4-axis Z-Tip-Tilt-Theta stage the height of the wafer plane in the DynamYX GT stage is only 115mm above

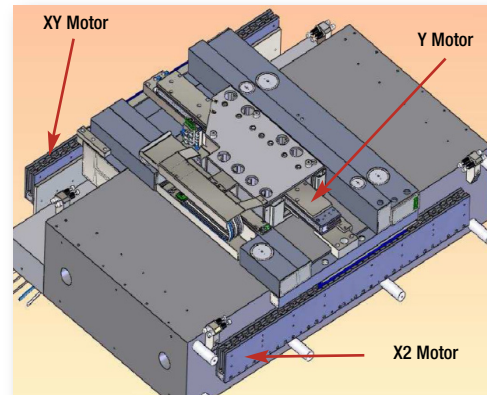

Three Linear Motors Drive the DynamYX GT and Datum Stage

the granite reference surface. The low profile nature of DynamYX contributes to the system's overall dynamic performance and attenuates the already minimal abbey offset effect of pitch and roll. If Newport is to supply the wafer chuck, the chuck (ideally ceramic), including vacuum lines to the chuck, and wafer lift pins may be supplied as an integrated solution.

Linear Motor Drives

The original DynamYX 300 and DynamYX RS "Reticle Stage" tables are driven by only two Ironless linear motors; one in the X-axis and one for the Y-axis. The rating of each motor is carefully considered based on the intended duty cycle/throughput requirements as to minimize the power dissipation of the system. For even higher throughput requirements, the DynamYX GT and all-new DynamYX Datum incorporate a second X axis linear motor which is driven in open loop mode. Unlike H-bridge air bearing designs which rely on a synchronized servo loop for positioning and stiffness, the monolithic ceramic guide found in all four designs defines the positioning reference and overall stiffness of the positioning elements. Controlling any of the four DynamYX stages is very much like controlling a conventional XY stack with one control signal for X and one for Y. For the GT and Datum stages, a

continued on pg. 6

continued from pg. 5

single X-axis control signal is split and fed into two amplifier channels where the output force is biased according to the linear motor ratings and total payload.

Most linear motors on the market were designed without focusing on the real needs of precision motion control applications where mass limits and efficiency are most critical. Newport air bearing stages benefit from our commitment to providing the highest possible performance by incorporating motors developed in-house that are optimized for the products and applications they address. Newport's linear motors have outstanding performance in the areas heat dissipation, time constant, force ripple, and structural integrity. From an efficiency standpoint, the performance of our motors is measured as the steepness per given motor volume where steepness is defined at the heat dissipated by a motor when delivering a given force (F2/W) and volume is simply the motor cross-section multiplied by the coil length. In situations where the rms acceleration values are extremely high and any heat loss is a problem, our motors feature sealed-forced air or recirculating water methods of cooling

Newport Air Bearing Selection Matrix					
	DynamYX Datum	DynamYX GT	DynamYX 150	DynamYX 300 GTL	DynamYX RS
Markets and Applications					
Micro Electronics					
Wafer Inspection	★★★★	★★★★	★★★★	★★★★	★
Optical Lithography	★★★★	★★★★	★★	★★	★
Nano Imprint Lithography	★★★★	★★★★	★★	★★	★
PCB Patterning	★	★	★	★	★
Memory Repair	★★★★	★★★★	★★	★★	★
Reticle Inspection & Repair	★	★	★	★	★★★★
Mask Writing	★★	★★	★★★★	★★	★★
Wafer Bump Inspection	★	★★	★★	★★	★
450mm Wafer Capable	★★★★	★	★	★	★
Flat Panel Display					
Automated Optical Inspection	★	★	★	★	★
Array Checking	★	★	★	★	★
Array Repair	★	★	★	★	★
Color Filter Generation	★	★	★	★	★
Laser Processing					
Thin Film Photovoltaic Scribing	★	★	★	★	★
Edge Isolation Generation	★	★	★	★	★
LED Scribing	★	★	★	★	★
Precision Micromachining	★	★	★★	★★	★★
Electro Optics					
Wave Guide Direct Writing	★	★	★★★★	★★★★	★★
Optical Calibration	★	★	★★★★	★★★★	★★
Performance and Physical Attributes					
General Criteria					
Long Travel Range	★★★	★★	★★	★★	★
High Load Capacity	★★★	★★	★★	★★	★
Smallest Footprint	★★★	★★★	★★★★	★★★	★★★★
Open Frame / Aperture	★	★	★	★	★★★★
Split XY Configurations	★	★	★	★	★
R-Theta Configurations	★	★	★	★	★
Positioning Performance					
Accuracy	★★★★	★★★★	★★★★	★★★★	★★★★
Repeatability	★★★★	★★★★	★★★★	★★★★	★★★★
Straightness & Flatness	★★★★	★★★★	★★★★	★★★★	★★★★
Position Stability	★★★★	★★★★	★★★★	★★★★	★★★★
Dynamic Capability					
Velocity Regulation	★★★★	★★★★	★★	★★	★★★★
Step-and-Settle	★★★★	★★	★★	★★	★★
Clean Transfer Function	★★★★	★★	★★	★★	★★

Applicability Rating Key	
Best Choice	★★★★
Well Suited	★★★
Possibly Applicable	★★
Not Suitable	★

DynamYX® Datum™ Ultra-High Performance Stage

Full throughput performance of the DynamYX Datum stage is realized when configured with a ceramic chuck. Ceramic chucks offer lower mass and improved flatness compared with metallic designs. An added benefit of using a ceramic chuck on a DynamYX stage is that the thermal expansion coefficients of the chuck and stage are matched which allows for the chuck to be directly mounted to the XY carriage. This direct mounting provides for the flattest and most thermally stable wafer surface possible in a single plane stage architecture.

When extreme XY accuracy is required, linear encoders may be replaced with a two (XY) or three (theta) axis interferometer system. By combining Newport's expertise in ceramics and optical surface finishing we are able to provide a cleanly integrated interferometer mirror solution with excellent surface quality and dynamic characteristics. As in the case of the ceramic chuck, these ceramic mirrors may be directly mounted to the either the XY carriage or chuck itself eliminating the complexity and instability of kinematic (or other) mirror mounting techniques. Newport's proprietary optical replication process offers a cost effective approach over traditional lapping methods for applications which require performance that cannot be achieved with linear encoders.



- Highest level of positioning performance available from a family of commercially available products
- Extensive use of advanced ceramic materials
- Low profile, fully pre-loaded single plane designs with integrated pressure vacuum air bearings
- Extremely rigid structures with high natural frequencies
- Linear Motors with integrated forced-air and water cooling conduits provide exceptional thermal stability
- Options for Z-Tip-Tilt, Theta, ceramic wafer chucks with integrated lift-pin mechanisms, and ceramic interferometer mirrors

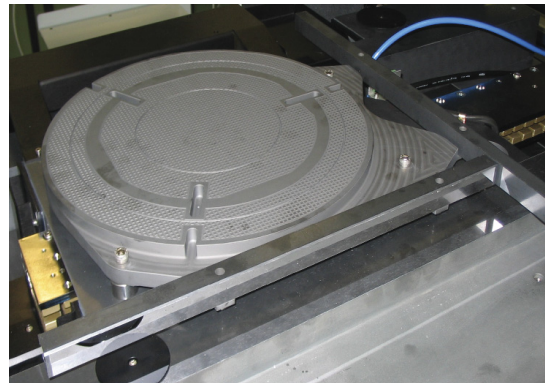

Ceramic Chuck with Integrated SiC Mirrors

Key Features

- Acceleration: 3G X-Axis, 5G Y-Axis
- Velocity: 1000mm/sec
- Repeatability: ± 25 nm (long term)
- Accuracy: 0.2 μ m (linear encoders)
- Natural Frequency: 300 Hz

Please refer to complete summary for additional details

DynamYX® GT High-Throughput Stage

- Similar in design to the DynamYX 300 model, this GT stage is intended for high-throughput applications with aggressive duty-cycles
- Extremely rigid structure and high load capacity air bearings provides up to 2G acceleration
- High-efficiency X and Y linear motors with integrated cooling drive moving masses through respective center of gravity locations
- Available with patented ZT3, Z-Tip-Tilt-Theta stage

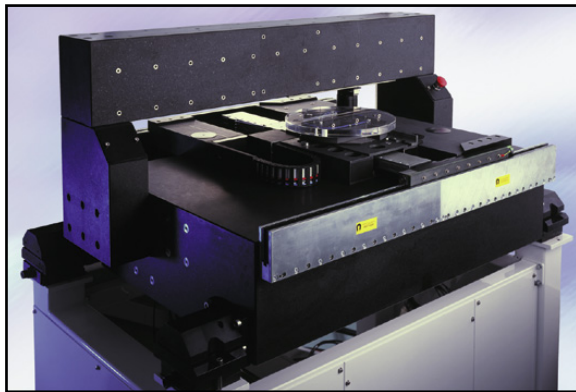

Compared to the DynamYX 300 stage, the GT version has larger linear motors with integrated cooling in X & Y, a second (X2) linear motor, and more rigid structure with larger air bearings for increased load capacity

Key Features

- Acceleration: 1.2G X-Axis, 2.0G Y-Axis
 - Velocity: 800mm/sec
 - Repeatability: $\pm 50\text{nm}$ (long term)
 - Accuracy: $0.3\mu\text{m}$
- Travel Range: 520mm by 350mm

Please refer to complete summary for additional details

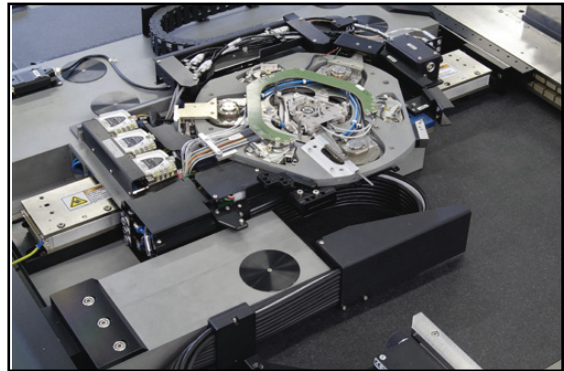

Newport's Patented ZT3 with Active Plane Drive Technology provides high-bandwidth, repeatable, and stable positioning for active wafer surface tracking applications. The compact design includes an air bearing theta off-set stage which clamps for ultimate stability

DynamYX® 150 & 300 Wafer Positioning Stage

Key Features

- Acceleration: 0.75G X-Axis, 1.5G Y-Axis
- Velocity: 400mm/sec
- Repeatability: $\pm 50\text{nm}$ (long term)
- Accuracy: $0.4\mu\text{m}$
- Travel Range: 520mm by 340mm

Please refer to complete summary for additional details

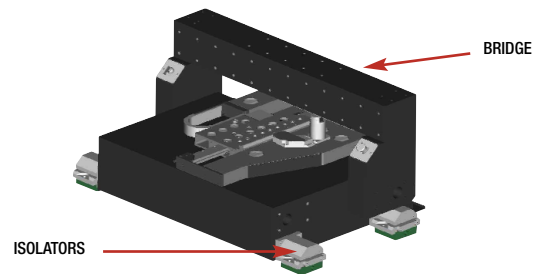

A Typical DynamYX 300 System is comprised of a granite base which serves as the reference surface for the XY air bearing carriage, the moving stage elements, an overhead bridge structure for installation of an optical system, and a set of vibration isolators.

- Designed for 300mm wafer test, measurement, and processing applications.
- Simple 3-piece architecture in a two motor design provides a cost effective solution for high accuracy and dynamic performance for step-and-settle and/or scanning applications
- Smallest footprint in Newport's line of air bearing wafer positioning stages

DynamYX® 300, GT, & DATUM Specification Summary

Design Details	DynamYX 300	DynamYX GT	DynamYX Datum
Stage Architecture	Single Plane XY Air Bearing, L-Shape Configuration		Single Plane XY Air Bearing, O-Shape Configuration
Material	Ceramic (SiC), Granite		
Drive Mechanism	Brushless linear servo motors (one motor each for X and Y)	Brushless linear servo motors (two motors for X, one motor for Y)	High Efficiency Brushless linear servo motors (two motors for X, one motor for Y)
Position Feedback	Non-contact optical linear encoders - Heidenhain LIF, Zerodur scale with 2 µm signal period - Heidenhain LIF, glass scale with 4 µm signal period		Laser Interferometer - Agilent Differential Interferometer, low drift
Bearings	Integrated Pressure-Vacuum Air Bearing		Integrated Micro-Structure Pressure-Vacuum Air Bearings
Cable Management	Fully integrated, clean-room compatible, single point exit/entry, minimal external force		
General Specifications			
Travel Range (standard, encoder or interferometer)	310 mm X-axis 340 mm Y-axis	380 mm X-axis 350 mm Y-axis	380 mm X-axis 350 mm Y-axis
Travel Range (maximum, encoder)	520 mm X-axis 340 mm Y-axis	520 mm X-axis 350 mm Y-axis	520 mm X-axis 350 mm Y-axis
Footprint (without bridge pillars, standard travel)	965 mm x 815 mm	1040 mm x 918 mm	1040 mm x 918 mm
Rated Payload (maintains dynamic specifications)	5 kg	6 kg	3 kg
Maximum Load Capacity	15 kg	30 kg	30 kg
Maximum Velocity (rated payload)	400 mm/sec X-axis 400 mm/sec Y-axis	800 mm/sec X-axis 500 mm/sec Y-axis	1000 mm/sec X-axis 1000 mm/sec Y-axis
Peak Acceleration (rated payload)	0.75 G X-axis 1.5 G Y-axis	1.2 G X-axis 2.0 G X-axis	3.0 G X-axis 5.0 G X-axis
RMS Acceleration (rated payload)	0.25 G X-axis 0.5 G Y-axis	0.8 G X-axis 1.1 G X-axis	1.1 G X-axis 1.1 G X-axis
Granite Base Thickness (standard travel)	250 mm	300 mm	300 mm
Total Weight	530 kg	590 kg	600 kg
Stiffness, First Natural Frequency (rated payload)	230 Hz	250 Hz	300 Hz
MTBF	20,000 hrs.	20,000 hrs.	20,000 hrs.
Performance Specifications			
Pitch, Yaw, Roll (300 mm by 300 mm travel)	<15 µrad	<10 µrad	<10 µrad
XY Straightness & Flatness (300 mm circle)	0.6 µm TIR	0.4 µm TIR	0.3 µm TIR
XY Straightness & Flatness (25 mm circle)	0.1 µm TIR	0.1 µm TIR	0.05 µm TIR
XYZ Position Stability (on-air)	±10 nm	±10 nm	±5 nm
XYZ Position Stability (clamped)	+/-1 nm	+/-1 nm	+/- 0.5 nm
XY Orthogonality	< 5µrad	< 5µrad	< 5µrad
Speed Stability (velocity ripple sampled at 2kHz and 400mm/sec)	0.1%	0.1%	0.05%
XY Accuracy with Zerodur Scale, TIR, XY error compensation, 0.1 degree C temperature stability (300 mm circle)	0.4 µm	0.3 µm	0.2 µm
XY Accuracy with Agilent Interferometer, Newport SiC Replica Mirrors, XY mapping (300 mm circle)	NA	100 nm	50 nm
SiC Replica Mirror Flatness	NA	0.3 µm / 300 mm 0.1 µm / 50 mm	
XY Bi-Directional Repeatability (long term, short or long displacement)	±50 nm	±50 nm	±25 nm
XY Bi-Directional Repeatability (short term, short or long displacement)	±10 nm	±10 nm	± 5 nm
Step-and-Settle Times (using Newport ND40 Passive Isolators)	Settling into ±0.1 µm window	Settling into ±0.1 µm window Note: Addition of Reaction Force Compensation System allows same step-and-settle times into ± 25 nm window	
300 mm step	< 950 msec X-axis	< 700msec X-axis	< 450 msec X-axis
	< 900 msec Y-axis	< 700 msec Y-axis	< 400 msec Y-axis
100 mm step	< 450 msec X-axis	< 350 msec X-axis	< 250 msec X-axis
	< 400 msec Y-axis	< 350 msec Y-axis	< 200 msec Y-axis
25 mm step	< 300 msec X-axis	< 250 msec X-axis	< 150 msec X-axis
	< 250 msec Y-axis	< 200 msec Y-axis	< 150 msec Y-axis
Ideal Interpolated Encoder Resolution	2 nm	2 nm	0.5 nm

Open Frame Capability

Newport's Air Bearing stages may be configured to support applications requiring an open-frame or transmitted light architecture. Examples of such applications include reticle inspection & repair, LED scribing, precision pick-and-place assembly.

All open-frame air bearing solutions are based on the same single plane architecture found in the DynamYX or HybrYX stages. When configured to allow simultaneous top and bottom viewing of the substrate/payload a cantilevered SiC Ceramic frame is mounted to the XY air bearing carriage. This rigid and light-weight frame supports and positions the substrate along a single XY plane while locating the substrate away from the moving elements of the stage providing the cleanest possible working environment.

The full-open-aperture accommodates flexible optical component integration as well as ease of service access. The footprint of this architecture is much smaller than traditional open-frame solutions.

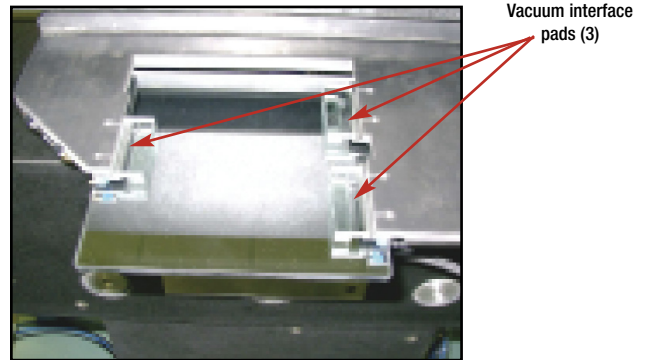

The ceramic reticle holder of the RS stage provides a vacuum-secured 3-point mask interface which is ESD safe. This mounting plane has a very tight parallelism tolerance with respect to the axes of travel.

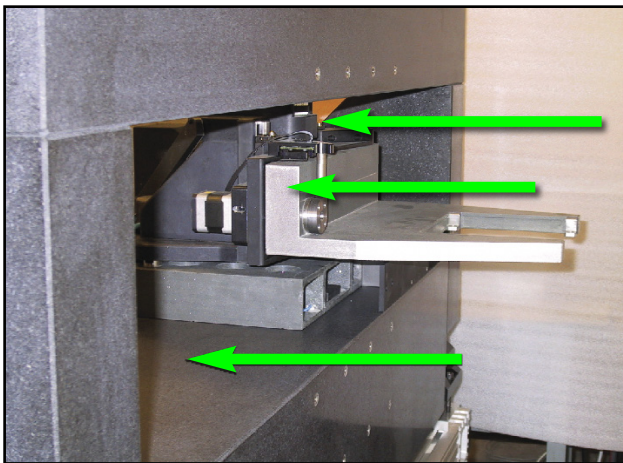

Reticle and Optics are located away from all moving stage elements where air flow prevents particles from entering clean compartment

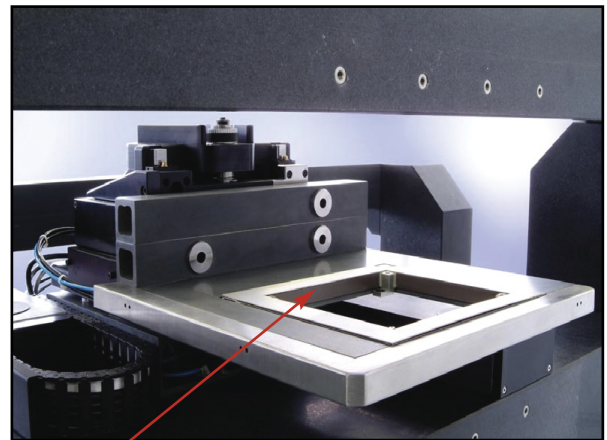

Reticle Under Test

The "Full-Open-Aperture" design provides unobstructed access to the front of the stage system and a completely open pallet for integration of optical assemblies

HybrYX® – High-Performance Solutions for Semiconductor Wafer Inspection, Flat Panel, PCB and Photovoltaic Applications

The HybrYX® single plane XY hybrid stages offers the advantages of a single plane air bearing stage at a much lower cost than previously possible. HybrYX is well suited for semiconductor wafer inspection systems as well as being an excellent choice for use in large substrate (flat panel display and photovoltaic panel) inspection and processing tools.

Innovative Architecture

HybrYX stages blend the cost-effectiveness of mechanical bearings with the precision of a single plane air bearing carriage to deliver a powerful combination of throughput, precision and value. During motion, a ceramic carriage freely slides in X and Y on a precision lapped granite reference plane using a proprietary pressure-vacuum air bearing design. This XY carriage is pressure-vacuum preloaded to, and guided along the Y-axis by a rigid and lightweight ceramic beam. The beam is supported (and guided) at each end by recirculating ball bearing carriages resulting in a low-profile design that is extremely rigid, well-damped, and capable of quick & precise point-to-point moves and exceptional high-speed scanning performance. For large payloads, such as Generation-5 LCD display or Photovoltaic panels, the HybrYX-G5 offers an oversized carriage with higher air bearing load capacity on both the horizontal and vertical reference surfaces.

Performance without Compromise

HybrYX was developed to overcome the disadvantages found in conventional “stacked” XY stage systems. Truck-and-rail based stages have limited performance capabilities, long-travel crossed roller bearing designs are hindered by large footprints and may not have adequate life-time or MTBF characteristics, and a (pure) dual axis air bearing is often cost prohibitive.

Key Features

- Excellent price-to-performance value for demanding industrial OEM applications
- Ideal choice for scanning applications requiring ultra-low velocity ripple and dynamic following error
- True single plane XY architecture with optional theta and Z-Tip-Tilt solutions
- Reliable, long-life operation well suited for high duty cycle environments
- Large (>1 meter) XY Travel range
- Scanning velocities up to 600mm/sec and 0.6G acceleration

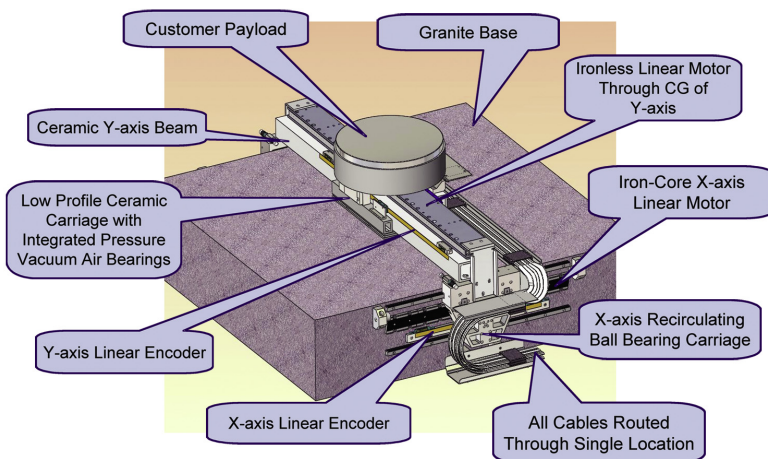

Newport Air Bearing Selection Matrix		HybrYX	HybrYX G5
Markets and Applications			
Micro Electronics			
Wafer Inspection	☆☆☆	☆	
Optical Lithography	☆	☆	
Nano Imprint Lithography	☆	☆	
PCB Paterning	☆☆	☆☆☆☆	
Memory Repair	☆	☆	
Reticle Inspection & Repair	☆	☆	
Mask Writing	☆	☆	
Wafer Bump Inspection	☆☆☆☆	☆	
450mm Wafer Capable	☆☆☆☆	☆☆	
Flat Panel Display			
Automated Optical Inspection	☆☆	☆☆☆	
Array Checking	☆☆	☆☆☆	
Array Repair	☆☆	☆☆☆	
Color Filter Generation	☆☆	☆☆☆	
Laser Processing			
Thin Film Photovoltaic Scribing	☆☆	☆☆☆	
Edge Isolation Generation	☆☆	☆☆☆	
LED Scribing	☆☆	☆☆☆	
Precision Micromachining	☆☆	☆☆	
Electro Optics			
Wave Guide Direct Writing	☆	☆	
Optical Calibration	☆☆	☆☆	
Performance and Physical Attributes			
General Criteria			
Long Travel Range	☆☆☆	☆☆☆☆	
High Load Capacity	☆☆☆	☆☆☆☆	
Smallest Footprint	☆☆	☆	
Open Frame / Aperture	☆	☆	
Split XY Configurations	☆	☆	
R-Theta Configurations	☆	☆	
Positioning Performance			
Accuracy	☆☆	☆☆	
Repeatability	☆☆	☆☆	
Straightness & Flatness	☆☆☆	☆☆☆	
Position Stability	☆☆☆	☆☆☆	
Dynamic Capability			
Velocity Regulation	☆☆☆	☆☆☆	
Step-and-Settle	☆☆	☆☆	
Clean Transfer Function	☆☆	☆☆	

Applicability Rating Key	
Best Choice	☆☆☆☆
Well Suited	☆☆☆
Possibly Applicable	☆☆
Not Suitable	☆

HybrYX[®] G5 Large Substrate Positioning Stage

The HybrYX G5 provides the advantages of a single plane architecture in a stage designed specifically for large payloads.

- Design is closely based on smaller HybrYX stage but with larger ceramic carriage and Y-axis guide beam
- Large, 1400mm travel in the Y (scanning) axis is well suited for up-to Generation 5 flat panel display substrates or photovoltaic panels

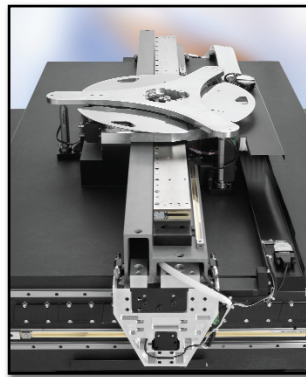

Optional Z-Tip-Tilt and Theta functionality without significant increase to mass and profile (height) (see page 18 for details)

The G5 stage is available with an optional Z-Tip-Tilt-Theta Stage which incorporates Newport's patented flexure guide found in the DynamYX GT stage. Like the DynamYX version, Active Plane™ Drive Technology provides fast, repeatable, and stable positioning for active surface tracking applications.

- Capable of providing $\pm 3\mu\text{m}$ accuracy over a full XY travel range of 1400mm by 400mm
- Long-life & high MTBF as air bearing is not limited by bearing travel/life-expectancy
- All axes driven by high-precision linear actuators
- Travel range: 10mm Z, ± 1 degree tip/tilt, ± 1 degree theta- Z, 1 μrad theta sensitivity
- Supports payloads up to 30Kg.

HybrYX[®] XY Hybrid Air Bearing Stage

Typically used as the "stepping" axis, the X-axis is driven by a pair of iron-core linear motors (one motor on each side of the stage) selected for their high efficiency and low-cost attributes. To optimize scanning performance, an ironless linear motor drives the Y-axis through the CG of the single plane carriage.

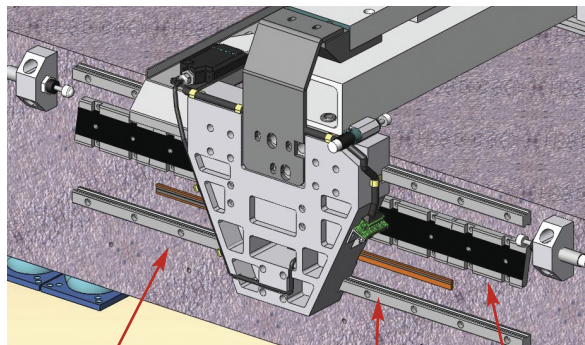

Double-Row Ball Bearing Slides with Ball Separators Provide Excellent Payload Capability, Low Noise Motion, and Long Service Life

Precision Linear Scale

High Efficiency Iron-Core Linear Motor

The unique hybrid architecture of HybrYX offers the following outstanding performance characteristics for demanding scanning applications:

- Z-Jitter & dynamic straightness of less than $\pm 25\text{nm}$ during high speed motion
- Better than 0.1% velocity ripple
- Compact 1200mm by 765mm footprint with 650mm by 350mm travel range
- Long-life & high MTBF as air bearing is not limited by bearing travel/life-expectancy

HybrYX® and HybrYX® G5 Specification Summary

Design Details	HybrYX	HybrYX-G5
Stage Architecture	Single Plane XY Air Bearing / Mechanical Bearing Hybrid	
Material	Ceramic (SiC), Granite	
Drive Mechanism	Brushless linear servo motor (Y-axis Ironless, X-axis Iron-core)	
Position Feedback	Non-contact optical linear encoders - Standard: Heidenhain LIDA, steel scale with 20 µm signal period - Optional: Heidenhain LIF, glass scale with 4 µm signal period - Optional: Renishaw Signum, Invar scale with 20 µm signal period	
Bearings	Pressure-Vacuum Air Bearing (XY Carriage and Y-travel), Recirculating ball-bearing (X-travel)	
Cable Management	Fully integrated, clean-room compatible, single point exit/entr. minimal external force	
General Specifications		
Travel Range (standard)	350 mm X-axis 650 mm Y-axis	450 mm X-axis 1400 mm Y-axis
Footprint (without bridge pillars)	1200 mm x 765 mm x 375 mm	2000 mm x 900 mm x 450 mm (with ZTT & Theta)
Rated Payload (maintains dynamic specifications)	14 kg	30 kg on ZTT & Theta
Maximum Load Capacity	20 kg	40 kg (without ZTT & Theta)
Maximum Velocity (rated payload)	300 mm/sec X-axis (stepping) 600 mm/sec Y-axis (scanning)	300 mm/sec X-axis (stepping) 600 mm/sec Y-axis (scanning)
Peak Acceleration (rated payload)	0.3 G X-axis 0.6 G Y-axis	0.15 G X-axis with ZTT & Theta 0.25 G X-axis with ZTT & Theta
RMS Acceleration (rated payload)	0.15 G X-axis 0.2 G Y-axis	0.075 G X-axis with ZTT & Theta 0.1 G X-axis with ZTT & Theta
Granite Base Thickness	250 mm	250 mm
Total Weight	750 kg	1400 kg
Stiffness, First Natural Frequency	150 Hz	150 Hz
MTBF	20,000 hrs.	20,000 hrs.
Performance Specifications		
Pitch, Yaw, Roll (300 mm by 600 mm travel)	<15 µrad	<15 µrad
Y-axis Straightness (300 mm line)	0.6 µm TIR	1 µm TIR
Y-axis Straightness (25 mm line)	0.1 µm TIR	0.15 µm TIR
Noise on Y-axis Straightness (sampled at >5 Hz.)	±25 nm	±25 nm
XY Flatness (300mm circle)	0.6 µm TIR	0.6 µm TIR
Y-axis Position Accuracy over 25 mm	± 250 nm with 20 µm LIDA scale ± 50 nm with 4 µm LIF scale	± 100 nm with 20 µm with Invar scale
Accuracy in XY (with linear and perpendicularity error compensation)	± 1.5 µm over 300 x 600 mm with 20 µm LIDA scale ±1.0 µm over 300 x 600 mm with 4 µm LIF scale	± 3 µm over 1.2 m x 0.4 m with 20 µm Invar Scale
Noise on XY Flatness (sampled at > 5Hz)	±20 nm	±25 nm
XY Orthogonality	< 10 µrad	< 20 µrad
Y-axis Speed Stability (velocity ripple sampled at 2kHz and 400mm/sec)	0.10%	0.10%
Step-and-Settle Times (using ND40 Passive Isolators)	Settling into ±100 nm window Note: Addition of Reaction Force Compensation System allows same step-and-settle times into ± 40 nm window	Settling into ±1 µm window Note: Addition of Reaction Force Compensation System allows same step-and-settle times into ± 0.25 µm window
300 mm step	< 1300 msec X-axis < 750 msec Y-axis	< 1350 msec X-axis < 900 msec Y-axis
100 mm step	< 650 msec X-axis < 360 msec Y-axis	< 750 msec X-axis < 500 msec Y-axis
25 mm step	< 350 msec X-axis < 300 msec Y-axis	< 350 msec X-axis < 300 msec Y-axis
Ideal Interpolated Encoder Resolution	2 nm	2 nm

Please Contact Newport For Drawings and Additional Information Related to the Air Bearing Products Described in This Brochure

SinguLYS™ - Dedicated single axis air bearing stage and bridge designs for scanning applications

The SinguLYS™ stage and bridge configurations combine high performance with modularity, making them ideal for single axis, split XY, and gantry applications. Specially designed for frictionless operation, both the S and B SinguLYS series of air bearing products are extremely sturdy, highly reliable, and require no maintenance and/or lubrication.

Zero Maintenance

Our totally noncontact air bearing, noncontact linear motor drive and noncontact feedback devise ensure years of maintenance free operation at high performance levels. Because there is no mechanical contact between moving elements, there is no wear or reduction in performance over time. Service life is virtually unlimited and since no lubrication is required, air bearings are ideal for cleanroom and medical applications.

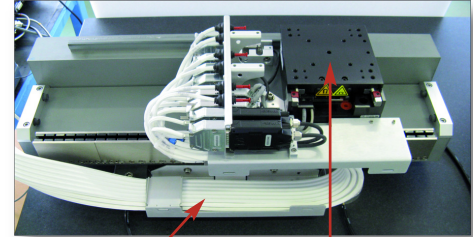

INTEGRATED CLEAN CABLE MANAGEMENT

CAPABILITY TO INTEGRATE Y-AXIS MECHANICAL STAGE

Newport Air Bearing Selection Matrix		
	SinguLYS S-370	SinguLYS B-1200
Markets and Applications		
Micro Electronics		
Wafer Inspection	☆☆	☆☆
Optical Lithography	☆	☆
Nano Imprint Lithography	☆☆☆	☆
PCB Patterning	☆	☆☆☆
Memory Repair	☆☆	☆☆
Reticle Inspection & Repair	☆	☆
Mask Writing	☆☆	☆
Wafer Bump Inspection	☆	☆
450mm Wafer Capable	☆☆☆	☆☆
Flat Panel Display		
Automated Optical Inspection	☆	☆☆☆☆
Array Checking	☆	☆☆☆☆
Array Repair	☆	☆☆☆☆
Color Filter Generation	☆	☆☆☆☆
Laser Processing		
Thin Film Photovoltaic Scribing	☆	☆☆☆☆
Edge Isolation Generation	☆	☆☆☆☆
LED Scribing	☆☆☆☆	☆
Precision Micromachining	☆☆☆	☆☆☆
Electro Optics		
Wave Guide Direct Writing	☆☆☆	☆
Optical Calibration	☆☆☆	☆☆☆
Performance and Physical Attributes		
General Criteria		
Long Travel Range	☆☆☆☆	☆☆☆☆
High Load Capacity	☆☆	☆☆☆☆
Smallest Footprint	☆☆☆	☆☆
Open Frame / Aperture	☆	☆
Split XY Configurations	☆☆☆☆	☆☆☆☆
R-Theta Configurations	☆☆☆☆	☆
Positioning Performance		
Accuracy	☆☆☆	☆☆☆
Repeatability	☆☆☆	☆☆☆
Straightness & Flatness	☆☆☆☆	☆☆☆
Position Stability	☆☆☆	☆☆☆
Dynamic Capability		
Velocity Regulation	☆☆☆☆	☆☆☆
Step-and-Settle	☆☆☆	☆☆☆
Clean Transfer Function	☆☆☆	☆☆☆

Applicability Rating Key	
Best Choice	☆☆☆☆
Well Suited	☆☆☆
Possibly Applicable	☆☆
Not Suitable	☆

SinguLYS S-370

The SinguLYS S-370 stage is manufactured from silicon carbide (SiC) ceramic components, similar to Newport's popular DynamYX and HybrYX stage product families. The body's extremely rigid and compact footprint with 3-point mounting allows this stage to be used in tight spaces typically reserved for mechanical bearing designs without the need for large, lapped mounting surfaces to maintain precise trajectory. The lightweight carriage features integrated pressure-vacuum air bearings which are guided by a precisely-lapped SiC body. Newport's new high precision stage is ideal for tasks with very high duty-cycles that require low angular deviation, tight velocity regulation, and high cleanliness standards.

	SinguLYS S-370 Air Bearing	XML350 Crossed Roller Bearing
Max Vel (XPS)	>500 mm/sec	300 mm/sec
Max Acc (XPS)	0.5G (5 kg load)	0.4G (5 kg load)
Pitch, Roll, Yaw	10 μ rad (TIR)	100 μ rad (TIR)
BI Dir Repeatability	40 nm (3 sigma)	80 nm (3 sigma)
Accuracy	100 nm (3 sigma), Zerodur scale	200 nm (3 sigma), Glass Scale
Speed Stability	<0.1%	<0.2%
Mounting Surface	3 Point (body is self-supporting)	Needs base with 10 μ m Flatness
Position Stability	Best	Good
Cleanliness	Best	Good
Life Expectancy	Best	Good

Key Features

- Travel range: 370 mm
- Incremental motion: 10 nm
- Max. speed: 500 mm/s
- Payload: 5 kg
- Controller: XPS / DRV02
- Dimensions (mm): 640 (L) x 300 (W) x 150 (H)

SinguLYS B-1200

The SinguLYS B-1200 air bearing bridge features a proprietary ceramic beam that is 3 times lighter than steel and offers triple the stiffness of granite. When used to replace a steel or granite-based design in an existing or next-generation tool, the properties of the B-1200 can improve acceleration and decrease settling times, which increases throughput and accuracy with minimal system redesign. The lightweight and rigid pressure-vacuum air bearing carriage accommodates high (10kg) cantilevered payloads with 2.5G acceleration and, unlike stages using mechanical bearings, minimizes contamination to the substrate below. Applications for Newport's B-1200 include Gen 8-11 flat panel display inspection, thin film photovoltaic scribing, and wafer processing.

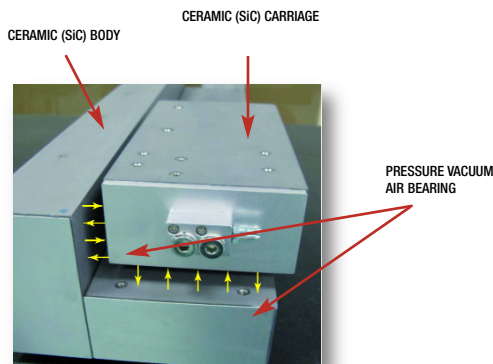

- Ceramic body provides extremely straight and flat reference surface over full travel of stage
- Ceramic carriage provides thermally stable reference and low moving mass

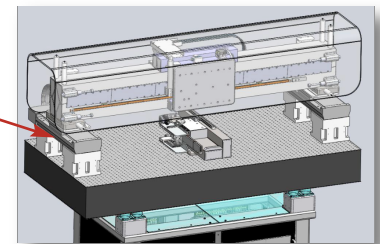

Key Features

- Travel range: 1200 mm
- Rated payload: 10 kg
- Max. speed: 2.5 m/s
- Max. acceleration: 2 G
- Efficient iron-core linear motor
- Natural frequency: >100 Hz

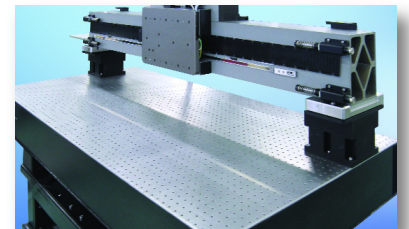

Bridge is often mounted in Gantry-Architecture and Moved by Linear Translation Stages

SinguLYS Specification Summary

Design Details	S-370 Single Axis Stage	B-1200 Single Axis Bridge
Stage Architecture	Single Axis Air Bearing Carriage and L-Shape Body	Single Axis, Self-Supporting Air Bearing Bridge and L-Shape Carriage
Material	Ceramic (SiC) Carriage and Body Brushless linear servo motor	Ceramic (SiC) Carriage and Body Brushless linear servo motor
Drive Mechanism	- Standard: XXmm Ironless Core - Optional: XXmm Ironless Core	- Standard: Iron-Core - Optional: XXmm Ironless Core
Recommended Amplifier	48 Volts, 7 Amps	200 V, 25 Amps
Position Feedback	Non-contact optical linear encoders - Standard: Zerodur scale with 4 μ m signal period - Optional: Steel scale with 20 μ m signal period	Non-contact optical linear encoders - Standard: steel scale with 20 μ m signal period - Optional: Zerodur scale with 20 μ m signal period
Bearings	Pressure-Vacuum Air Bearing with vacuum preload, directly machined into carriage	Pressure-Vacuum Air Bearing with vacuum preload (vacuum and magnetic preload when equipped with ironcore motor), directly machined into carriage
Cable Management	Fully integrated, clean-room compatible, single point exit/entry, minimal external force	Fully integrated, clean-room compatible, single point exit/entry, minimal external force
General Specifications		
Travel Range (standard)	370 mm	1200 mm
Travel Range (max possible)	620 mm	5000mm
Footprint (standard)	630 mm x 275 mm x 175 mm	1800 mm x 350 mm x 350 mm
Rated Payload (maintains dynamic specifications)	5 kg	10 kg
Maximum Load Capacity	10 kg	30 kg
Maximum Velocity (rated payload and recommended amplifier)	900 mm/sec	2500 mm/sec
Peak Acceleration (rated payload and recommended amplifier)	- Standard: 0.5 G - Optional: 1.0 G	2 G
RMS Acceleration (rated payload)	0.2 G (RMS)	1 G (RMS)
Moving Mass (Carriage)	4 kg	18 kg
Total Weight (standard)	16 kg	80 kg
Recommended Mounting Configuration	3 points beneath body	3 points at beam extremities
Natural Frequency	> 100 Hz	> 100 Hz
MTBF	20,000 hrs.	20,000 hrs.
Standard Performance Specifications		
Pitch, Yaw, Roll	10 μ rad over 300 mm	20 μ rad over 1000 mm
Repeatability of Pitch, Yaw, Roll	0.3 μ rad	0.3 μ rad
Straightness, Flatness	1 μ m TIR over 300 mm	5 μ m TIR over 1000 mm
Noise on Straightness, Flatness (sampled > 5 Hz)	+/- 50 nm	+/- 100 nm
Accuracy (with error compensation, temperature stabilized within 0.2 °C)	\pm 100 nm over 300 mm with Zerodur scale \pm 500 nm over 300 mm with steel scale	\pm 2 μ m over 1000 mm with steel scale \pm 0.5 μ m over 1000 mm with Zerodur scale
Bi-Directional Repeatability	40 nm (3 sigma)	80 nm (3 sigma)
Speed Stability (velocity ripple sampled at 2kHz and 500mm/sec)	0.1 %	0.1 %
Step-and-Settle Times (using ND40 Passive Isolators and XPS controller)	Settling into \pm 100 nm window	Settling into \pm 100 nm window
1000 mm step	na	< 750 msec
300 mm step	< 750 msec	< 350 msec
25 mm step	< 250 msec	< 250 msec
1 mm step	< 100 msec	< 100 msec
Minimum Incremental Motion	10 nm	25 nm
Ideal Interpolated Encoder Resolution	1 nm	5 nm

ZT3 z tip tilt theta with active plane technology

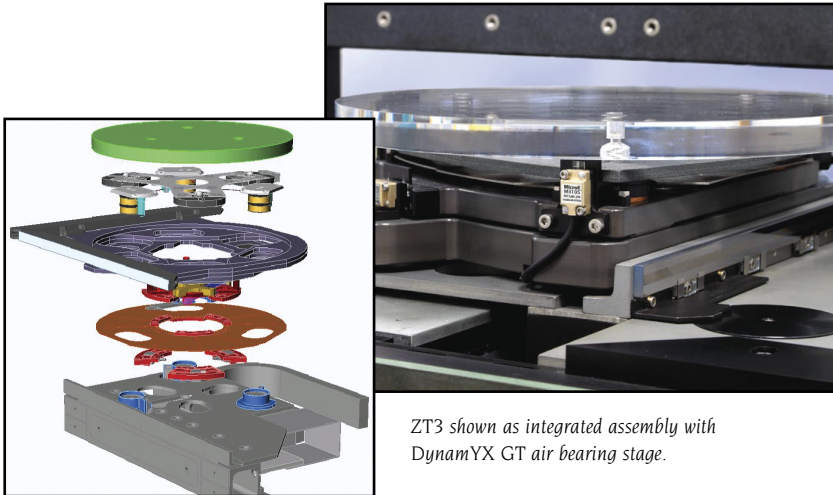

ZT3 shown as integrated assembly with DynamYX GT air bearing stage.

Key Features

- Travel Range:
5 mm Z; ± 2 mrad (tip/tilt); $\pm 3^\circ$ (Qz)
- High resolution linear encoders directly measure movement of all voice coil driven axes
- Minimum incremental motion: 5 nm
- XY Stiffness: >200 Hz
- Step & Settle: 5 μ m displacement in 40 ms settled to ± 20 nm

The patented ZT3 (Z-Tip-Tilt-Theta) is designed for applications such as optical lithography or wafer inspection that require active alignments of a wafer/chuck in vertical, tip, tilt, and theta. The Active Plane™ drive technology provides high-bandwidth repeatable and stable positioning without compromising the dynamic performance of the XY stage. The ZT3 integrates cleanly within the SiC carriage of DynamYX GT and DynamYX Datum™ stages and is also available as a standalone version for use with other high performance XY stages. The compact design includes an air bearing theta off-set stage which clamps for ultimate stability and a lift-pin mechanism for simplified wafer loading and unloading. An optional piezo driven fine-theta axis with 0.1 μ rad sensitivity may be added to allow for active yaw control/compensation.

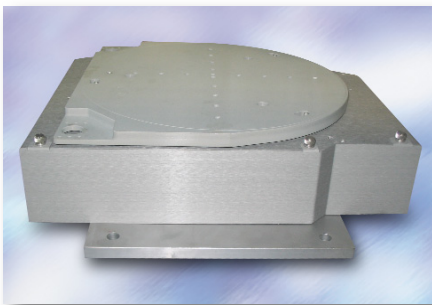

Metal enclosure of standalone ZT3 shields internal components from surrounding environment



The ZT3 concept is homogeneous with the DynamYX GT/Datum concept in that they both follow low mass, low profile, high stiffness, and non-contact design philosophies. With a chuck surface height of 113 mm above the top surface of the reference granite, a DynamYX GT with integrated ZT3 is the industry's lowest profile 6-axis air bearing positioning system.

Newport's Differentiating Design Philosophy

Newport's philosophy of "designed-in" precision is an integral feature of many Newport products. Our goal is to **minimize the number of primary stage elements** (bases, carriages, reference surfaces) and to incorporate into the sub-assemblies **critical alignment (reference) features** as to greatly reduce and/or eliminate the need for complex (and costly) assembly, alignment, and testing procedures. This design philosophy is realized by creating monolithic structures with integral tolerances that are part of the manufacturing process of each part.

All Newport air bearing stages have two critical elements in-common; **a single plane XY carriage** manufactured from a rigid, light-weight silicon carbide (SiC) ceramic and **system of pressure-vacuum air bearings** that are directly machined-into the ceramic components providing a low-profile monolithic structure. Additional benefits of this approach include greater system stability (performance over time is less likely to drift and require recalibration), ease of transport (especially critical in large systems), and inventory management (easier to keep high-level integrated components in stock to control lead times and cover spare parts).

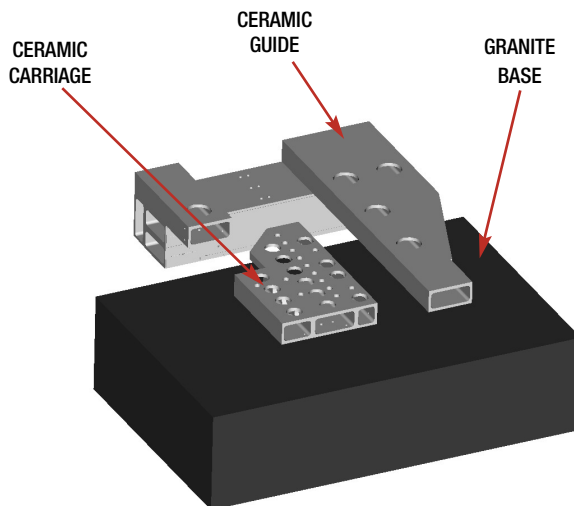

Clean and Simple Architecture of DynamYX includes Three Monolithic Elements

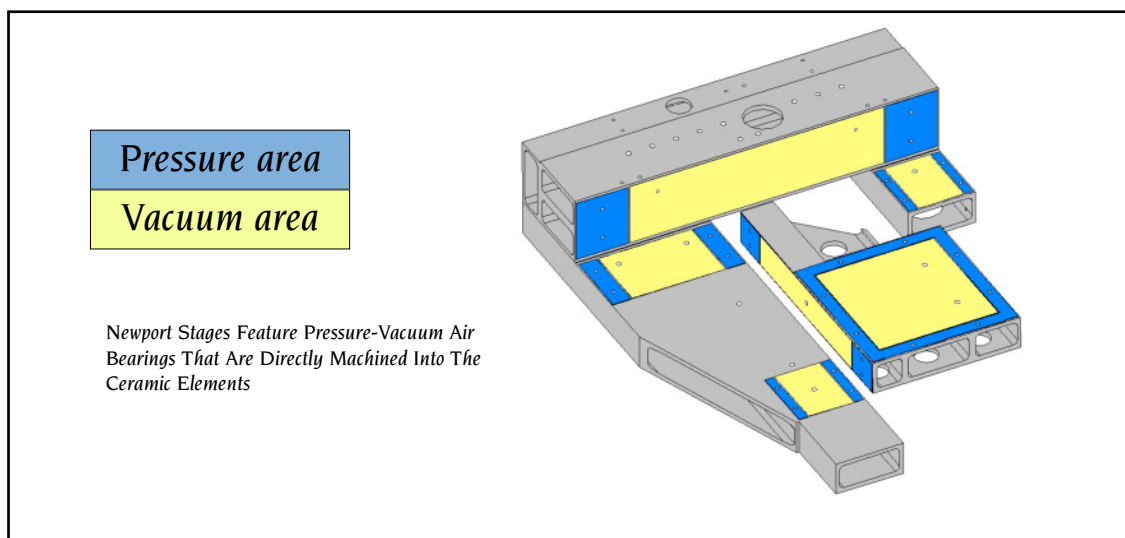

Capabilities in Advanced Ceramic Materials

Newport has built upon decades of experience in motion solutions to create customizable OEM technology platform that cater to application-specific needs. These platforms have been successfully implemented in partnership with OEM's in many applications.

These customized technology platforms are designed from leading technologies and combine the collective knowledge of Newport in materials, manufacturing, assembly and motion control. Technologies such as air bearings, linear and rotary ball bearings, high resolution direct encoders, linear motors, piezos, flexures, ceramic materials and vibration isolation are optimally integrated into these platforms to address the customer's specific requirements.

Newport's expertise in ceramic materials is "home-grown" with a team of engineers specialized in material science and a fully equipped in-house machining center. These R&D and manufacturing resources allow us to quickly react to challenging customer requirements as well as maintain a constant effort in product advancements needed to keep pace with industry road maps.

The basic properties of these core (ceramic) components used in the construction of our products are **low mass** (density is similar to aluminum) and **high strength or stiffness** (Young's modulus similar to steel).



SiC in House Manufacturing Using High End Ultrasonic Machines



SiC Air Bearing Component assembly

Material Properties of SiC, Granite, and Other "Traditional" Air Bearing Stage Materials					
	Granite	Steel	Aluminum	Newport SiC	
				Standard	Advanced
Density: d	2.7	7.8	2.7	2.7	3
Young's Modulus: E, (GPa)	70	210	70	240	350
Stiffness (E/d)	25	25	25	90	120
Thermal Conductivity: TC (W/m*K)	2	50	150	30	140
Thermal Expansion: TE (10 ⁻⁶ /K)	5	11	22	3.5	3.5

The advantages that have been demonstrated by using these advanced materials go beyond stages which have very high accuracy and throughput capabilities, Our systems are thermally stable with clean and repeatable transfer functions capable of tuning in with ease to applications requiring high servo bandwidth, thus delivering best in class performance in the most challenging applications.

SiC is not only used as the building blocks for our air bearing solutions, we have also developed complimentary products such as bridge structures, wafer chucks, interferometer feedback and mirrors that further differentiate our product offering.

Ceramic Wafer Chuck

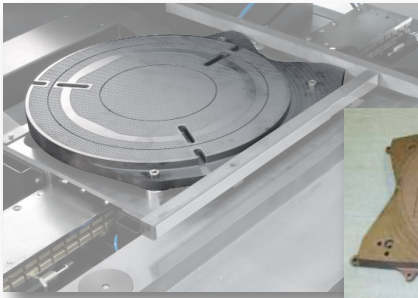

SiC wafer chuck on DynamYX® Datum™.



Support for 200 & 300 mm wafers,
<2% backside contact, 100 nm
flatness per 50 mm² area.

Key Features

- Provides lower mass and greater flatness
- Thermal coefficient of expansion values of stage and chuck are matched
- Allows for direct mounting of chuck to carriage
- Best possible wafer surface flatness and stability
- Minimal contact design for exceptional backside cleanliness

Key Features

- Two or three axis measurement at plane of wafer
- Ceramic (SiC) mirrors with master replicated surfaces
- Allows for direct mounting of mirrors to chuck
- Replica process yields exceptional mirror quality and is more cost-effective than lapping
- High thermal conductivity (> zerodur) minimizes thermal surface distortion
- Rigid material with very high (~900 Hz) natural frequency

Interferometer Feedback and SiC Mirrors

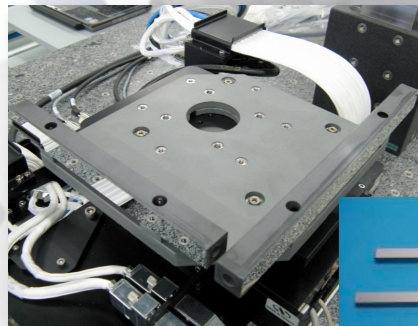

Ceramic plate with integrated (replica) interferometer mirrors on Newport XML crossed roller bearing stages can provide 50 nm XY bidirectional repeatability (when used with XPS controller and Renishaw interferometer).



Thermally matched mirrors are directly affixed to ceramic wafer chuck.

Very Large and Rigid Ceramic Bridge Structures

Most of our systems are delivered with an overhead bridge structure that allows direct integration of the optical system. The bridge structure is an important piece to meet the overall system performance as precision and position stability are typically defined between the wafer and a reference point on the bridge. Newport has tremendous experience in materials and structural analysis and provides the optimum design solution for each application.

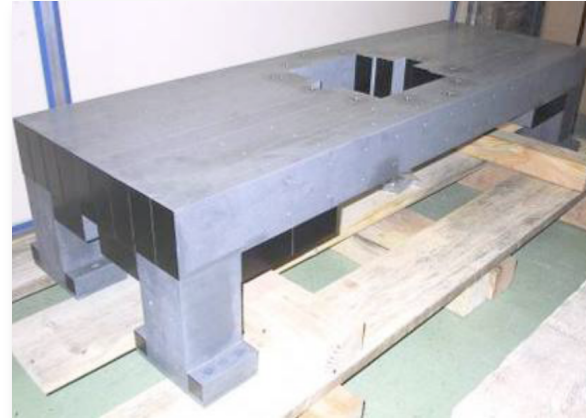
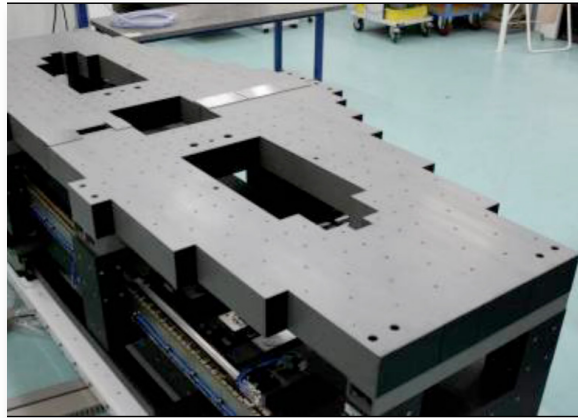
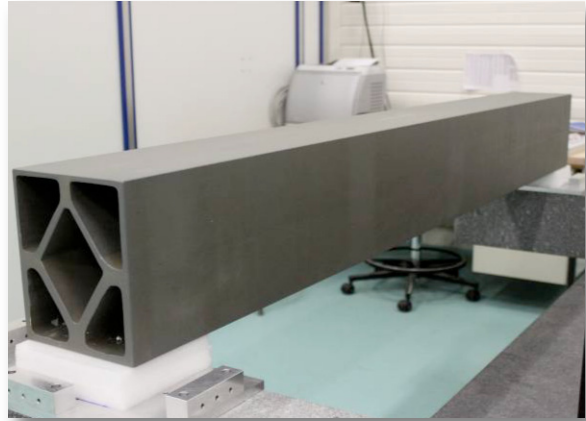

Air Bearing System Options and Accessories

Motion Controller

Newport recommends the XPS motion controller for optimized performance and ease of integration with Newport air bearing stages. The XPS is a standalone, 19 inch (4U) motion controller capable of controlling and driving up to 8 axes of brushless linear/rotary, brushed-DC, and stepping motors. With all controller, interpolator, amplifier, and power supply components housed within the XPS, cable management from the single cable exit (common to both the DynamYX and HybrYX families) is clean and efficient. XPS supports a wide range of motion control features including:

- High-speed 10/100 Base-T Ethernet communication interface
- Advanced 10KHz servo loop with variable PID's, low-pass & notch filters, and feedforward compensation
- Sophisticated 3D error mapping, linear and orthogonal error compensation
- Extensive I/O functionality including low-latency position compare and input latching



Reaction Force Compensation System

- Cost effectively enhances settling performance of passive isolators
- Provides settling performance comparable to higher-cost active isolation systems
- Easy to integrate, requires no position feedback or other sensing



DynamYX Datum Air Bearing Stage Equipped with an XY Reaction Force Compensation System

Bridge Structures

- Available in granite or silicon carbide (SiC) designs
- Customized mounting holes and precision reference surfaces

Pneumatics Panel

- Single pressure source input
- Includes regulators, filters, vacuum generators (venturi), safety interlocks

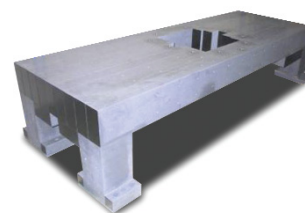
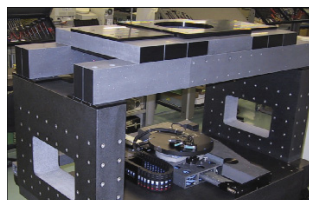

The Newport Resource®

The Newport Resource® Catalog

The Newport Resource® is a fully comprehensive sourcebook for making, managing and measuring light. The latest edition features over 15,000 products, and details the complete range of our standard motion control products through tutorials, descriptions, technical specifications and drawings. Motion control products data sheets can also be downloaded from the online catalog at www.newport.com



Newport's standard motion control products are available in the shortest possible lead times and can be ordered online or by placing an order at your local Newport sales office or with your representative. To receive a free copy of the Newport Resource, please register online at www.newport.com or contact us.

Newport Online

Visit us at www.newport.com to shop online and browse the latest news and events, products categories, technical information, interactive 3D CAD drawings, special offers and much more!

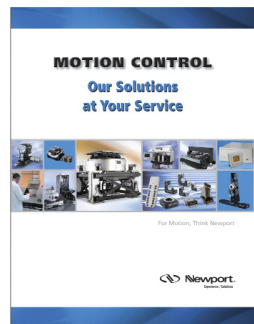

Newport Corporation, Global Headquarters
1791 Deere Avenue, Irvine, CA 92606, USA

www.newport.com

PHONE: 1-800-222-6440 1-949-863-3144 **FAX:** 1-949-253-1680 **EMAIL:** sales@newport.com
Complete listings for all global office locations are available online at www.newport.com/contact

PHONE
Belgium +32-(0)0800-11 257
China +86-10-6267-0065
France +33-(0)1-60-91-68-68
Japan +81-3-3794-5511
Taiwan +886 -(0)2-2508-4977

EMAIL
belgium@newport.com
china@newport.com
france@newport.com
spectra-physics@splasers.co.jp
sales@newport.com.tw

PHONE
Irvine, CA, USA +1-800-222-6440
Netherlands +31-(0)30 6592111
United Kingdom +44-1235-432-710
Germany / Austria / Switzerland +49-(0)6151-708-0

EMAIL
sales@newport.com
netherlands@newport.com
uk@newport.com
germany@newport.com

© 2011 Newport Corporation. All rights reserved. Newport, the Newport logo, DynamYX, HybrYX and Newport Resource are registered trademarks of Newport Corporation. SinguLYS, Active Plane and DATUM are trademarks of Newport Corporation.

BR-05110 (05/11)