

Models 1601 and 1611

User's Manual

High-Speed Photoreceivers

【*ν*】

Warranty

New Focus, Inc. guarantees its products to be free of defects for one year from the date of shipment. This is in lieu of all other guarantees, expressed or implied, and does not cover incidental or consequential loss.

Contents	Warranty	2
	Introduction	4
	Theory	5
	Operation	9
	Specifications	11

This Page intentionally left blank.

Introduction

The New Focus Models 1601 and 1611 1-GHz, low-noise photoreceivers address the needs of the photodetector community in the area of low-noise, high-gain, RF photoreception. These photoreceivers are AC coupled and are capable of driving up to 1 V peak to peak into a 50- Ω load. The minimum bandwidth is 1 GHz with a current gain of 700 V/A.

The performance of these units is achieved through the use of solid RF design together with the implementation of some of the latest advances in commercially available amplifier chips. The detector is shielded to avoid RF pickup. New Focus offers two models to match your different wavelength requirements.

These photoreceivers have very large gain \times bandwidth products, low noise performance, high drive capability and a large dynamic range. They will enable wide bandwidth low-noise detection of signals distributed over fiber-optic cables or found in high resolution spectroscopy, fiber-optic sensors, optical metrology, and many other applications.

Theory

The Model 1601 photoreceiver consists of a silicon PIN photodiode followed by a low-noise amplifier. The Model 1611 photoreceiver consists of an InGaAs PIN photodiode with the same amplifier.

The 1601 photodetector has a maximum current of 5 mA and the 1611 photodetector has a maximum current of 10 mA. Therefore, the maximum input optical power is 10 mW for both detectors. The responsivity of the photodiode is shown in Figs. 2a and 2b. Power is delivered through a connector on the back of the unit, and the entire package is shielded to eliminate RF pickup. Typical frequency responses for the Models 1601 and 1611 are shown in Figs. 3a and 3b.

The amplifier is a low-noise, silicon amplifier having a voltage gain of 15 and an input impedance of 50 Ω . This unit can be cascaded with other 50- Ω amplifiers.

Transmission lines connect the photodiode to the amplifier and the amplifier to the output. Microstrip transmission lines are used to preserve speed and eliminate parasitic inductance and capacitance that can cause ringing. Rise time of the diode/amplifier combination is less than 400 ps.

The AC-coupled 1601 and 1611 incorporate blocking capacitors and a DC bias monitor circuit as shown in Fig. 1. The corner frequency of the high-pass filter on the AC-coupled output is approx. 30 kHz; the corner frequency of the low-pass filter on the DC bias monitor output is approx. 20 kHz. The DC bias monitor gain is 10 V/mA.

Fig. 1

Functional block diagram of the Models 1601 and 1611.

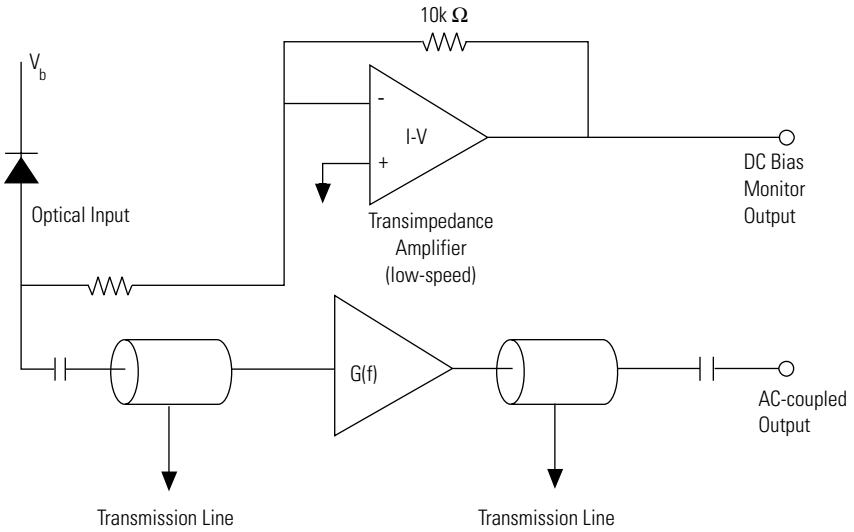
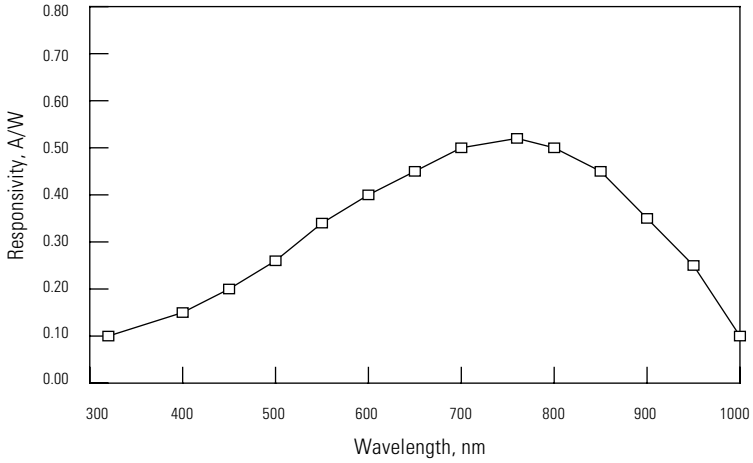

Fig. 2a

Responsivity of the photodiode used in the Model 1601.

**Fig. 2b**

Responsivity of the photodiode used in the Model 1611.

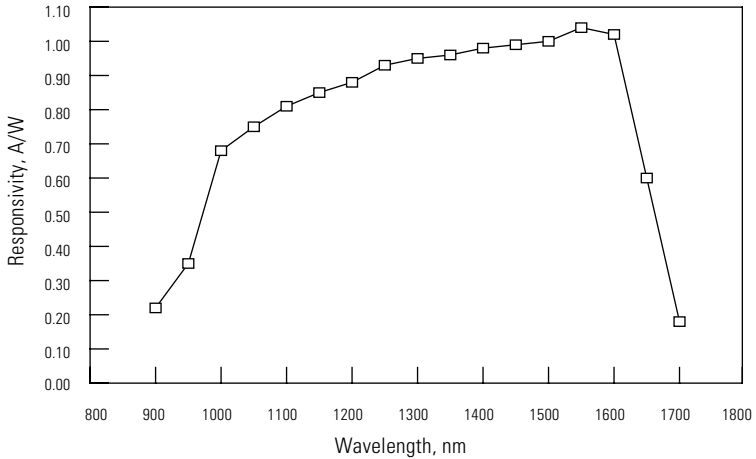
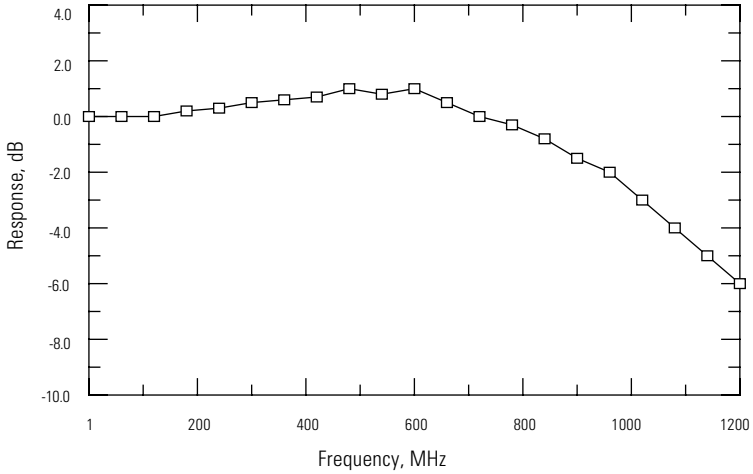
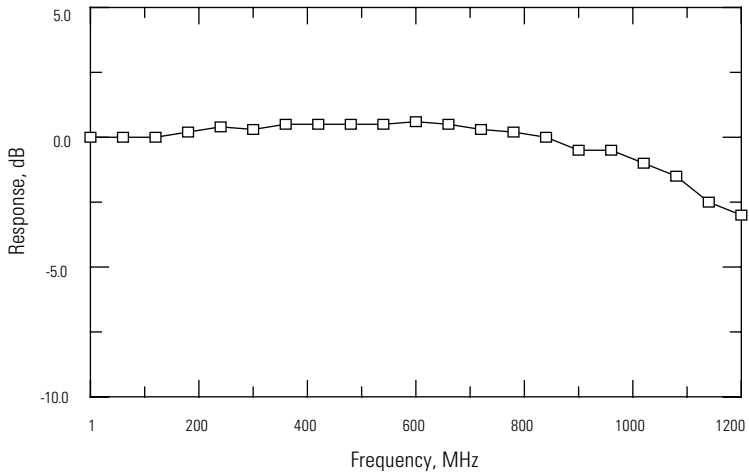

Fig. 3a

*Typical frequency response of
the Model 1601.*

**Fig. 3b**

*Typical frequency response of
the Model 1611.*



Operation

To obtain optical input:

1. Plug one end of the power cable on to the connector on the back of the module and the other end into a ± 15 -V power supply. (We recommend the New Focus Model 0901 power supply.) Turn on the supply.

Two different power cables have been shipped with your detector: a New Focus Model 0921 banana plug-to-microconnector cable and a Model 0922 microconnector-to-microconnector cable. If you have a New Focus Model 0901 power supply, use the Model 0922 cable on one of the supply's 0.3-A microconnector outputs. Do not use the Model 0921 on the Model 0901 power supply's 0.1-A banana outputs since they do not provide enough current for the receiver. Use the Model 0921 cable only with a power supply other than the 0901 providing a minimum of 0.25 A of current on ± 15 V. The convention of the three banana plugs is:

<u>Banana Plug</u>	<u>Voltage</u>
Red	+15 V
Green	COM/GND
Black	-15 V

2. Turn on the optical beam.
3. For direct optical beam input, align the module in front of the optical beam.

For fiber-optic cable input, connect the fiber-

optic input cable from your optical source to the ST- or FC-input connector port on the front of the module.

Note: To operate the receiver in the linear region, keep the input power levels below the Input Power specification on pages 11 and 12. (The Input Power is wavelength dependent and is inversely proportional to the responsivity.)

To set up the output connection:

1. If your RF measurement instrument has a male connector, connect it directly to the SMA female output connector (labeled “AC”) on the back of the module or connect with the appropriate cable.

If your instrument has a female connector, connect with the appropriate cable.

2. Monitor the DC bias on the output labeled “DC” with the provided SMB-to-BNC cable.

Model 1601 Specifications

Dimensional

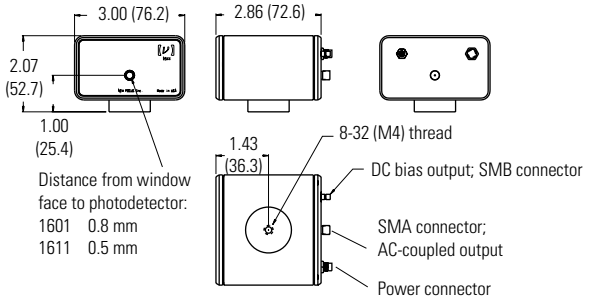

Performance

Coupling:	AC
Bandwidth (3 dB):	30 kHz–1 GHz
Wavelength Range:	320–1000 nm
Photodiode Material:	Silicon PIN
Photodiode Size:	400- μ m diameter
Power Requirements:	± 15 V DC; 300 mA
Risetime:	400 ps (est.)
Current Gain:	700 V/A
Input Noise Current:	16 pA/ $\sqrt{\text{Hz}}$
N.E.P.:	31 pW/ $\sqrt{\text{Hz}}$ (@760 nm)
Output Current:	10 mA (max into 50 Ω)
Input Power: (Linear Operation)	2 mW (max @ 760 nm)
Input Power (CW):	10 mW (max w/o damage)
Dynamic Range:	>60 dB (typ)

Connectors

Input:	FC, or direct
RF Output:	SMA
DC Bias Monitor:	SMB

Model 1611 Specifications

Dimensional

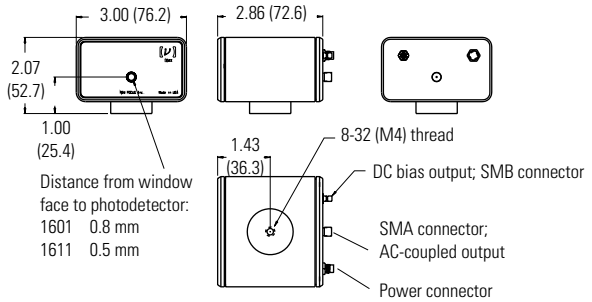

Performance

Coupling:	AC
Bandwidth (3 dB):	30 kHz–1 GHz
Wavelength Range:	900–1700 nm
Photodiode Material:	InGaAs PIN
Photodiode Size:	100- μ m diameter
Power Requirements:	± 15 V DC; 300 mA
Risetime:	400 ps (est.)
Current Gain:	700 V/A
Input Noise Current:	16 pA/ $\sqrt{\text{Hz}}$
N.E.P.:	20 pW/ $\sqrt{\text{Hz}}$ (@1.3 μ m)
Output Current:	10 mA (max into 50 Ω)
Input Power: (Linear Operation)	1 mW (max @ 1.3 μ m)
Input Power (CW):	10 mW (max w/o damage)
Dynamic Range:	>60 dB (typ)

Connectors

Input:	FC, or direct
RF Output:	SMA
DC Bias Monitor:	SMB