



XM-S Series

Ultra-Precision Linear Motor Stages



 **Newport**[®]

USER'S MANUAL

Warranty

Newport Corporation warrants this product to be free from defects in material and workmanship for a period of 1 year from the date of shipment. If found to be defective during the warranty period, the product will either be repaired or replaced at Newport's discretion.

To exercise this warranty, write or call your local Newport representative, or contact Newport headquarters in Irvine, California. You will be given prompt assistance and return instructions. Send the instrument, transportation prepaid, to the indicated service facility. Repairs will be made and the instrument returned, transportation prepaid. Repaired products are warranted for the balance of the original warranty period, or at least 90 days.

Limitation of Warranty

This warranty does not apply to defects resulting from modification or misuse of any product or part.

CAUTION

Warranty does not apply to damages resulting from:

- **Incorrect usage:**
 - **Load on the stage greater than maximum specified load.**
 - **Carriage speed higher than specified speed.**
 - **Improper grounding.**
 - **Connectors must be properly secured.**
 - **When the load on the stage represents an electrical risk, it must be connected to ground.**
 - **Excessive or improper cantilever loads.**
- **Modification of the stage or any part thereof.**



CAUTION

Please return equipment in the original (or equivalent) packing.

You will be responsible for damage incurred from inadequate packaging if the original packaging is not used.

This warranty is in lieu of all other warranties, expressed or implied, including any implied warranty of merchantability or fitness for a particular use. Newport Corporation shall not be liable for any indirect, special, or consequential damages.

© 2019 by Newport Corporation, Irvine, CA. All rights reserved.

Original instructions.

No part of this document may be reproduced or copied without the prior written approval of Newport Corporation. This document is provided for information only, and product specifications are subject to change without notice. Any change will be reflected in future publications.

Table of Contents

Warranty	ii
EC Declaration of Conformity.....	v
Definitions and Symbols.....	vii
Warnings	viii
Caution	x
<hr/>	
1.0 — Introduction.....	1
<hr/>	
2.0 — Description	2
2.1 Design Details	3
<hr/>	
3.0 — Characteristics.....	3
3.1 Definitions	3
3.2 Mechanical Specifications	5
3.3 Load Characteristics and Stiffness	5
3.4 Stage Weights	5
3.5 Example of Parameters “ScalingAcceleration” & “AccelerationLimit” ..	6
3.6 Estimated Moving Mass for XM-S Stages	8
<hr/>	
4.0 — Drives and Motors	9
4.1 Motor Characteristics	9
4.2 Position Feedback Signals.....	9
4.3 Pinouts.....	9
Motor Connector.....	10
Encoder Connector.....	10
Thermistor Connector.....	10
4.4 Cables	11
<hr/>	
5.0 — Stage Installation.....	12
5.1 Unpacking	12
<hr/>	
6.0 — Connection to Newport Controllers.....	13
6.1 Warnings on Controllers	13
6.2 Connection.....	14
6.3 Wiring	14
<hr/>	
7.0 — Connection to Non-Newport Electronics	15
7.1 Connections.....	15
<hr/>	

8.0	— Dimensions	16
9.0	— Accessories	17
9.1	Granite Base for Ultra Surface Flatness	17
10.0	— Maintenance	18
10.1	Maintenance	18
10.2	Repair	18
10.3	Calibration	18
	Service Form	19

EC Declaration of Conformity



2 Tech Drive
Andover, MA 01810
www.mksinst.com

EU27 Declaration of Conformity

Application of Council Directive(s):

- Electromagnetic Compatibility Directive (EMCD) – 2014/30/EU
- Machinery Directive – 2006/42/EC
- Restriction of Hazardous Substances Directive (RoHS3) – (EU) 2015/863⁽⁷⁾
- Waste Electrical and Electronic Equipment – Directive 2012/19/EU



Standard(s) to which conformity is declared:

- EN 61326-1:2013 – (EMC)
- EN ISO 12100:2010 Safety of Machinery – General Principles of Design – Risk Assessment and Risk Reduction

Emissions:

EN 55011: 2016 +A1:2017⁽⁴⁾ Industrial, scientific and medical equipment - Radio-frequency disturbance characteristics - Limits and methods of measurement

Immunity:

- EN 61000-4-2:2009 EMC/Electrostatic Discharge Immunity Test
- EN 61000-4-3:2006+A2:2010 EMC/Radiated Radio Frequency Electromagnetic Field Immunity Test
- EN 61000-4-4:2012 EMC/Electrical Fast Transient/Burst Immunity Test
- EN 61000-4-6:2014 EMC/Conducted Disturbances induced by Radio Frequency Fields Immunity Test
- EN 61000-4-8:2010 EMC/Power Frequency Magnetic Field Immunity Test

Manufacturers Name: MKS Instruments, Inc., 2 Tech Drive, Andover, MA 01810 USA

Authorized Representatives Name & Location: _____

Equipment Type/Description: **Ultra Precision Linear Motor Stage**

Model Number(s)⁽⁶⁾: **XML210-S, XML350-S, XMS50-S, XMS100-S, XMS160-S**

The object of the declaration described above is in conformity with the relevant Community harmonization legislation. MKS product conforms to the above Directive(s) and Standard(s) only when installed in accordance with manufacturer’s specifications. This declaration has been issued under the sole responsibility of the manufacturer.

Date: 5/17/2022

Le Cointe Hervé – Quality Director

4) Class A, Group 2
6) Compliance of the above model numbers requires the use of a braided shielded cable properly terminated at both ends – if so noted in the MKS Instruction Manual.
7) RoHS Directive has to be checked for in scope products; cannot CE mark without compliance to RoHS. RoHS Directive can be unchecked only for systems which MKS sells which qualify for “Large Scale Industrial Tool” exclusion.

UK Declaration of Conformity



2 Tech Drive
 Andover, MA 01810
www.mksinst.com

UK Declaration of Conformity

Application of Council Directive(s):

- Electromagnetic Compatibility Directive (EMCD) – 2014/30/EU
- Machinery Directive – 2006/42/EC
- Restriction of Hazardous Substances Directive (RoHS3) – (EU) 2015/863⁽⁷⁾
- Waste Electrical and Electronic Equipment – Directive 2012/19/EU



Standard(s) to which conformity is declared:

- BS EN 61326-1:2013 – (EMC)
- BS EN ISO 12100:2010 Safety of Machinery – General Principles of Design – Risk Assessment and Risk Reduction

Emissions:

- EN 55011: 2016 +A1:2017⁽⁴⁾ Industrial, scientific and medical equipment - Radio-frequency disturbance characteristics - Limits and methods of measurement

Immunity:

- BS EN 61000-4-2:2009 EMC/Electrostatic Discharge Immunity Test
- BS EN 61000-4-3:2006+A2:2010 EMC/Radiated Radio Frequency Electromagnetic Field Immunity Test
- BS EN 61000-4-4:2012 EMC/Electrical Fast Transient/Burst Immunity Test
- BS EN 61000-4-6:2014 EMC/Conducted Disturbances induced by Radio Frequency Fields Immunity Test
- BS EN 61000-4-8:2010 EMC/Power Frequency Magnetic Field Immunity Test

Manufacturers Name: MKS Instruments, Inc., 2 Tech Drive, Andover, MA 01810 USA

Authorized Representatives Name & Location: _____ / _____

Equipment Type/Description: **Ultra Precision Linear Motor Stage.**

Model Number(s) ⁽⁶⁾: **XML210-S, XML350-S, XMS50-S, XMS100-S, XMS160-S.**

The object of the declaration described above is in conformity with the relevant Community harmonization legislation. MKS product conforms to the above Directive(s) and Standard(s) only when installed in accordance with manufacturer's specifications. This declaration has been issued under the sole responsibility of the manufacturer.

Date: 5/17/2022

Le Cointe Hervé – Quality Director

4) Class A, Group 2
 6) Compliance of the above model numbers requires the use of a braided shielded cable properly terminated at both ends – if so noted in the MKS Instruction Manual.
 7) RoHS Directive has to be checked for in scope products; cannot CE mark without compliance to RoHS. RoHS Directive can be unchecked only for systems which MKS sells which qualify for "Large Scale Industrial Tool" exclusion.

Definitions and Symbols

The following terms and symbols are used in this documentation and also appear on the product where safety-related issues occur.

General Warning or Caution



The exclamation symbol may appear in warning and caution tables in this document. This symbol designates an area where personal injury or damage to the equipment is possible.

The following are definitions of the Warnings, Cautions and Notes that may be used in this manual to call attention to important information regarding personal safety, safety and preservation of the equipment, or important tips.



WARNING

Warning indicates a potentially dangerous situation which can result in bodily harm or death.



CAUTION

Caution indicates a potentially hazardous situation which can result in damage to product or equipment.

NOTE

Note indicates additional information that must be considered by the user or operator.

European Union CE Mark



The presence of the CE Mark on Newport Corporation equipment means that it has been designed, tested and certified as complying with all applicable European Union (CE) regulations and recommendations.

Warnings and Cautions



ATTENTION

This stage is a Class A device. In a residential environment, this device can cause electromagnetic interference. In this case, suitable measures must be taken by the user.

Warnings



WARNING

The motion of objects of all types carries potential risks for operators. Ensure the protection of operators by prohibiting access to the dangerous area and by informing the personnel of the potential risks involved.



WARNING

The magnetic channel included in this device has the potential to disrupt pacemakers. Consequently, it is recommended that individuals maintain a distance of 1 meter or more from the stage as a precautionary measure.

WARNING

Do not use this stage when its motor is emitting smoke or is unusually hot to the touch or is emitting any unusual odor or noise or is in any other abnormal state.

Stop using the stage immediately, switch off the motor power and then disconnect the electronics power supply.

After checking that smoke is no longer being emitted contact your Newport service facility and request repairs. Never attempt to repair the stage yourself as this can be dangerous.

WARNING

Make sure that this stage is not exposed to moisture and that liquid does not get into the stage.

Nevertheless, if any liquid has entered the stage, switch off the motor power and then disconnect the electronics from power supply.

Contact your Newport service facility and request repairs.



WARNING

Do not insert or drop objects into this stage, this may cause an electric shock, or lock the drive.

Do not use this stage if any foreign objects have entered the stage. Switch off the motor power and then disconnect the electronics power supply.

Contact your Newport service facility for repairs.

WARNING

Do not place this stage in unstable locations such as on a wobbly table or sloping surface, where it may fall or tip over and cause injury.

If this stage has been dropped or the case has been damaged, switch off the motor power and then disconnect the electronics power supply.

Contact your Newport service facility and request repairs.

WARNING

Do not attempt to modify this stage; this may cause an electric shock or downgrade its performance.

**WARNING**

Do not exceed the usable depth indicated on the mounting holes (see section “Dimensions”). Longer screws can damage the mechanics or cause a short-circuit.

WARNING

Do not exceed speed and load limitations as specified in chapter 3.3.

Caution

CAUTION

Do not place this stage in a hostile environment such as X-Rays, hard UV,... or in any vacuum environment.

CAUTION

Do not place this stage in a location affected by dust, oil fumes, steam or high humidity. This may cause an electric shock.

CAUTION

Do not leave this stage in places subject to extremely high temperatures or low temperatures. This may cause an electric shock.

- Operating temperature: +10 to +35 °C
 - Storage temperature: -10 to +40 °C (in its original packaging)
-

CAUTION

Do not move this stage if its motor power is on.

Make sure that the cable to the electronics is disconnected before moving the stage. Failure to do so may damage the cable and cause an electrical shock.

CAUTION

Be careful that the stage is not bumped when it is being carried. This may cause it to malfunction.

CAUTION

When handling this stage, always unplug the equipment from the power source for safety.

CAUTION

When the carriage is in its end-of-run position, it is strongly recommended not to go beyond this point as this may damage the stage mechanism.

CAUTION

Contact your Newport service facility to request cleaning and specification control every year.

CAUTION

You may have unfortunately put your fingers on the optical scale. This can cause failures while the stage is operating. In order to obtain an optimal operation, we advise to clean this optical scale with isopropyl alcohol.

Ultra-Precision Linear Motor Stages

XM-S Series

1.0 Introduction

This manual provides operating instructions for the stage that you have purchased in the XM-S Series.



XMS50-S, XMS160-S and XML350-S stages.

RECOMMENDATION

We recommend you read carefully chapters 4.0 and 5.0 for the connection to an electronics, before using a XM-S stage.



A typical XYZ assembly using XML210-S, XMS50-S and GTS30V

2.0 Description

The XM-S Series is the ultimate solution for the most demanding manufacturing and test & measurement applications. It meets ultra-precision motion requirements with high dynamics and reliability for 24/7 production environments. Typical applications include semiconductor wafer inspection, direct laser lithography, sensor test-and calibration and ultra-precision assembly.

Unlike screw driven stages, the XM-S stages employ a center-driven, ironless linear motor as the driving element. Since the linear motor is a frictionless direct drive device, there is no backlash or hysteresis, wind-up or stiction limiting the motion performance. The linear motor drive also offers the advantage of higher speed, acceleration and system responsiveness with no wear to motor brushes or drive screws. The extra-large, ironless motor coil ensures zero cogging for ultra-smooth velocity control at all speeds and provides a higher efficiency compared to alternative stage designs. This results in significant less heat dissipation which is generally the main limit for ultra-precision motion applications. To further improve thermal management and its effect on stage performance, the XM-S stages take also benefit of a sophisticated length decoupling of the magnetic track from the stage carriage.

XM-S stages are machined from stress-relieved 7075 aluminum ensuring long-term strength and stability. All critical stage surfaces undergo multiple machining processes and precision grinding under strict temperature and quality control, to further improve overall performance and accuracy. The T-shape carriage used on the XM-S stages provides the optimum solution for precision XY assemblies without impacting the stage preload. It also supplies a higher robustness and is more tolerant to non-ideal mounting conditions than stages with a C-shape carriage.

To ensure the most accurate trajectory control, XM-S stages feature high-class matched pairs of anti-creep crossed roller bearings. The lack of any re-circulating elements in the XM-S stages lead to outstanding ripple-free motion adequate for the most demanding scanning and inspection systems. Moreover, the geared retainers on these bearings prevent from bearing cage migration, which can occur with other linear bearings.

Precision position feedback is supplied by a high accuracy LIF 481 Heidenhain linear scale. The precision alignment and mounting of this low thermal expansion scale in the center of the stage minimizes the impact of temperature changes on stage repeatability and accuracy. The encoder signals are interpolated by Newport's XPS motion controller with sub-nm resolution and less than 10 nm noise for outstanding position sensitivity and stability. Absolute home position and limit signals are incorporated on the same scale without any further electronics or mechanics for improved reliability and accuracy. In general, all electronics are attached to the stationary base. So there are no moving cables inside the stage resulting in an extremely compact design with exceptional reliability and safety.

2.1 Design Details

Base material	High-strength 7075 Aluminum
Bearings	Anti-creep crossed roller bearings
Drive mechanism	3-phase synchronous ironless linear motor (without Hall effect sensors)
Motor initialization	Utilizes XPS controller patented feature that avoids large motions during initialization, without using Hall effect sensors
Motor commutation	Done by the XPS controller using encoder signals
Feedback	Heidenhain LIF 481 scale, 1 Vpp, 4 μm signal period, 32768-fold signal subdivision when used with XPS controller
Limit switches	Optical, on encoder's fiducial track
Origin	Optical, at center of travel, including mechanical zero signal
Drive type	Brushless DC Servo

3.0 Characteristics

3.1 Definitions

Specifications of our products are established in reference to ISO 230 standard part II “Determination of accuracy and repeatability of positioning numerically controlled axes”.

This standard gives the definition of position uncertainty which depends on the 3 following parameters:

Absolute Accuracy

Difference between ideal position and real position.

Accuracy

Difference between ideal position and real position after the compensation of linear errors.

Linear errors include: cosine errors, inaccuracy of screw or linear scale pitch, angular deviation at the measuring point (Abbe error) and thermal expansion effects. All Newport motion electronics can compensate for linear errors.

The relation between absolute accuracy and on-axis accuracy is as follows:

$$\text{Absolute Accuracy} = \text{Accuracy} + \text{Correction Factor} \times \text{Travel}$$

Repeatability

Ability of a system to achieve a commanded position over many attempts.

Reversal Value (Hysteresis)

Difference between actual position values obtained for a given target position when approached from opposite directions.

Minimum Incremental Motion (MIM or Sensitivity)

The smallest increment of motion a device is capable of delivering consistently and reliably.

Resolution

The smallest increment that a motion device can theoretically move and/or detect. Resolution is not achievable, whereas MIM, is the real output of a motion system.

Yaw, Pitch

Rotation of carriage around the Z axis (Yaw) or Y axis (Pitch), when it moves.

The testing of accuracy, repeatability, and reversal error are made systematically with test equipment in controlled environment ($20^{\pm 1}$ °C).

A linear cycle with 21 data points on the travel and 4 cycles in each direction gives a total of 168 points.

Guaranteed and Typical Specifications

Guaranteed maximum performance values are verified per Newport's A167 metrology test procedure. For more information, please consult the metrology tutorial section in the Newport catalog or at www.newport.com

3.2 Mechanical Specifications



	XMS-S	XML-S
Travel range (mm)	50, 100, 160	210, 350
Minimum Incremental Motion, linear ⁽⁴⁾ (μm) (with XPS-DRV11 Drive)	0.001	
Uni-directional repeatability, guaranteed ⁽¹⁾⁽⁴⁾ (μm)	0.05	
Bi-directional repeatability, guaranteed ⁽¹⁾⁽⁴⁾ (μm)	0.08 or ±0.04	
On-axis accuracy, guaranteed ⁽¹⁾⁽⁴⁾ (μm)	1.5 or ±0.75	3 or ±1.5
Maximum speed (mm/s)	300	
Maximum acceleration (m/s ²)	5	
Max. force (cont.) (N)	16	37
Load capacity, horizontal (N)	100	300
Straightness, flatness, guaranteed ⁽¹⁾⁽²⁾ (μm)	1.5 or ±0.75	3 or ±1.5
Pitch, guaranteed ⁽¹⁾⁽²⁾⁽⁴⁾ (μrad) ⁽³⁾	50 or ±25	100 or ±50
Yaw, guaranteed ⁽¹⁾⁽²⁾⁽⁴⁾ (μrad) ⁽³⁾	50 or ±25	100 or ±50
MTBF (h)	20,000	

- 1) For the definition of Typical and Guaranteed specifications see "Motion Basics Terminology & Standards" Tutorial at www.newport.com
- 2) Middle 80% of travel.
- 3) To obtain arcsec units, divide μrad value by 4.8.
- 4) Requires operation in a controlled environment to achieve specification.



CAUTION

To reach specifications stated, stages must be fixed on a plane surface with a flatness of 5 μm.

3.3 Load Characteristics and Stiffness

Normal Load Capacity (Cz)

Maximum load a stage can move while maintaining specifications.

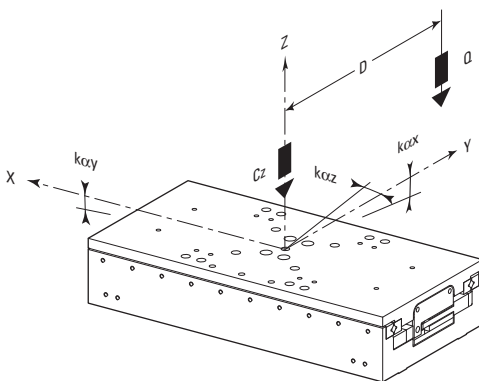

	XMS50	XMS100	XMS160	XML210	XML350
Cz, Normal centered load capacity (N)	100	100	100	300	300
kcx, Compliance in roll (μrad/Nm)	3.5	2.0	1.5	0.5	0.1
kcy, Compliance in pitch (μrad/Nm)	6.0	2.5	2.0	2.0	0.7
kcz, Compliance in yaw (μrad/Nm)	8.0	3.5	2.0	1.0	0.2
a, Construction parameter (mm)	109	109	109	155	155
Q, Off-center load where D = Cantilever distance in mm	$Q \leq Cz \div (1 + D/a)$				

3.4 Stage Weights

The stage weights indicated below do not include the cables.

	Mass [lb (kg)]	
	Stage	Carriage M _{car}
XMS50-S	5.5 (2.5)	2.6 (1.2)
XMS100-S	7.7 (3.5)	4.0 (1.8)
XMS160-S	9.9 (4.5)	5.1 (2.3)
XML210-S	28.7 (13.0)	16.8 (7.6)
XML350-S	48.5 (22.0)	26.0 (11.8)

3.5 Example of Parameters “ScalingAcceleration” & “AccelerationLimit”

This example is based on Newport XPS controller and XPS-DRV02 driver.

Two parameters have to be updated in the parameter file, according to the payload put onto the XM-S stage:

- The parameter "ScalingAcceleration" is used by the controller to scale the output voltage sent to the driver.

It indicates the theoretical maximum acceleration (friction not taken in account) of the XM-S carriage when the maximum voltage (10 volts) is applied to the driver.

- The parameter "AccelerationLimit" indicates the theoretical maximum acceleration that the controller will be able to require from the XM-S carriage. It correspond to the XM-S peak force.

For XPS controller and XPS-DRV02 driver, these parameters can be calculated using the following formulas, where the payload must be entered in kg:

$$\text{XMS-S ScalingAcceleration(Payload)} = 70357 \cdot \frac{[\text{mm/s}^2]}{(\text{Payload} + \text{Mcar})}$$

$$\text{XML-S ScalingAcceleration(Payload)} = 97232 \cdot \frac{[\text{mm/s}^2]}{(\text{Payload} + \text{Mcar})}$$

XMS160-S Examples:

$$\text{ScalingAcceleration(0)} = 30590 \text{ mm/s}^2$$

$$\text{ScalingAcceleration(10)} = 5720 \text{ mm/s}^2$$

$$\text{AccelerationLimit(Payload)} = \frac{\text{ScalingAcceleration(Payload)}}{1.1}$$

XMS160-S Examples:

$$\text{AccelerationLimit(0)} = 27809 \text{ mm/s}^2$$

$$\text{AccelerationLimit(10)} = 5200 \text{ mm/s}^2$$

These formulas are explained below:

Inputs from the system

- Motor:

- Motor force constant:

$$\text{XMS-S: MotorForceConstant} = 19.9 \text{ N/Amp. rms}$$

$$\text{XML-S: MotorForceConstant} = 27.5 \text{ N/Amp. rms}$$

- Motor thermal resistance:

$$\text{XMS-S: MotorRth} = 1.8 \left[\frac{\text{K}}{\text{Watt}} \right]$$

$$\text{XML-S: MotorRth} = 1.3 \left[\frac{\text{K}}{\text{Watt}} \right]$$

- Motor constant at 300 K:

$$\text{XMS-S: MotorK} = 24 \left[\frac{\text{Newton}^2}{\text{Watt}} \right]$$

$$\text{XML-S: MotorK} = 97 \left[\frac{\text{Newton}^2}{\text{Watt}} \right]$$

- Driver:

XPS-DRV02 driver is using sine/cosine commutation on its input. Its maximum current of 5 A is obtained for a 10 V input, so:

$$\text{MaxDriverCurrent} = 5 \text{ Amp.}$$

$$\text{TransImpedenceDriver} = 0.5 \text{ Amp./V}$$

- **Mechanics:**
 - XM-S carriage mass: See chapter: “Stage Weights” below.

- **System:**

XM-S rms force is defined to keep motor heating below 20 °C:

$$XM-S_RmsForce = \sqrt{\frac{20 \cdot [K] \cdot MotorK}{MotorRth}}$$

XMS-S_RmsForce = 16 Newtons

XML-S_RmsForce = 37 Newtons

XM-S peak force is defined to allow two time the rms force. This value is lower than the theoretical peak force of the motor:

XMS-S_PeakForce = 32 Newtons

XML-S_PeakForce = 74 Newtons

The rms current limitation of the driver is set according to XM-S rms force:

$$DriverMaximumRMSCurrent = \frac{XM-S_RmsForce}{MotorForceConstant} \sqrt{2} \left[\frac{Amp.}{Amp. rms} \right]$$

XMS-S DriverMaximumRMSCurrent = 1.14 Amp.

XML-S DriverMaximumRMSCurrent = 1.90 Amp.

The peak current limitation of the driver is set according to XM-S peak force:

$$DriverMaximumPeakCurrent = \min \left(\frac{XM-S_PeakForce}{MotorForceConstant} \sqrt{2} \left[\frac{Amp.}{Amp. rms} \right] \cdot 1.1; MaxDriverCurrent \right)$$

XMS-S DriverMaximumPeakCurrent = 2.5 Amp.

XML-S DriverMaximumPeakCurrent = 4.2 Amp.

The integration time of the driver I²t limitation is set to allow to apply the peak current for 4 seconds. This is obtained with an integration time of 15 s, which is lower than the motor thermal time constant.

DriverRMSIntegrationTime = 15 s

Example for a XML210-S stage with a 3 kg load

Inputs from the user

- Load on the carriage: Load = 3 kg

Calculation

- **MovingMass:**

MovingMass = Mcar + Load

- **ScalingAcceleration:**

$$ScalingAcceleration = \frac{MotorForceConstant \cdot 10 [Volts] \cdot TransImpedenceDriver}{\sqrt{2} \left[\frac{Amp.}{Amp. rms} \right] \cdot (Mcar + Load)}$$

ScalingAcceleration = **9172 mm/s²**

- **LimitAcceleration:**

$$LimitAcceleration = ScalingAcceleration \cdot \frac{DriverMaximumPeakCurrent}{MaxDriverCurrent} \cdot \frac{1}{1.1}$$

LimitAcceleration = **27856 mm/s²**

3.6 Estimated Moving Mass for XM-S Stages



CAUTION

Stages with linear motor such as those of the XM-S Series, are sensitive to the load variation and its stiffness. The typical example below shows the behavior of the displacement in accordance with the underestimated/overestimated moving mass.

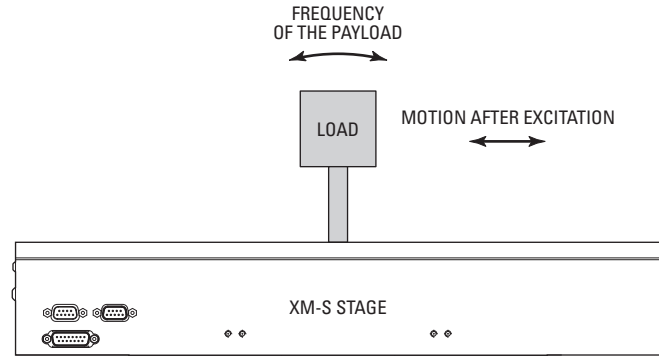

Driving in force requires a good adjustment of the controller/driver theoretical acceleration parameter (ScalingAcceleration) which depends on the moving mass.

Moving mass too high vs adjustment

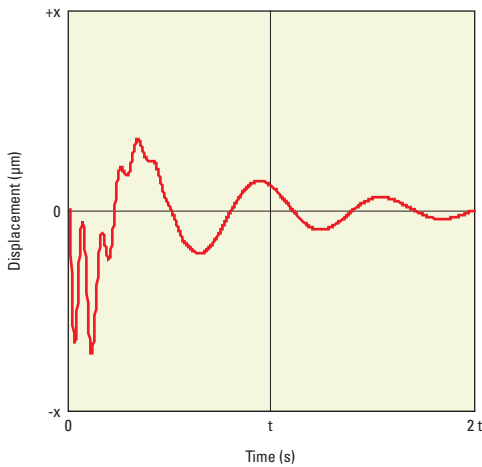

Moving mass too low vs adjustment

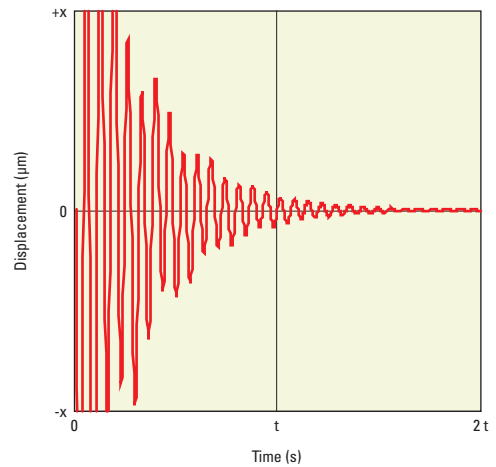

Moving mass good vs adjustment

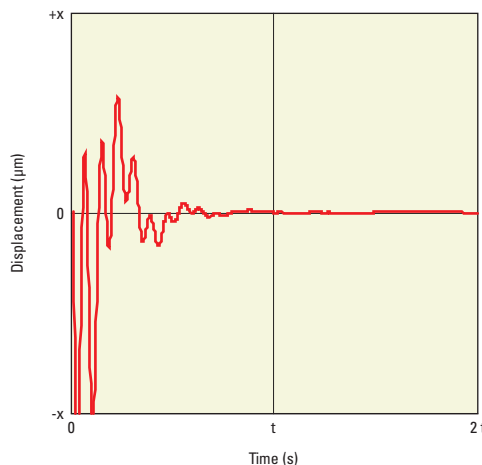

4.0 Drives and Motors

4.1 Motor Characteristics

XM-S stages are equipped with a brushless DC-motor (3-phase synchronous ironless linear motor) and a Heidenhain scale.

	Motor Constant (N ² /W)	Magnet Pitch (mm)	Nominal Voltage (V)	Max. RMS Current (A)	Max. Peak Current (A)	Resistance per Phase (Ω)	Inductance per Phase (mH)
XMS-S	24	30	48	1.1	2.5	5.5	1.6
XML-S	97	42	48	1.9	4.2	2.6	2

4.2 Position Feedback Signals

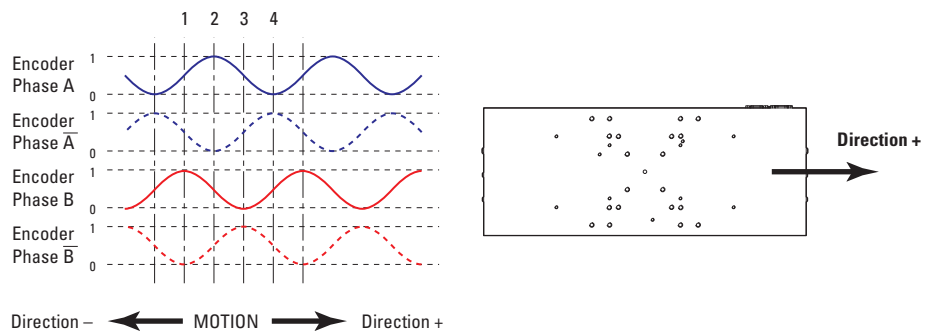

4.3 Pinouts

The XMS-S stage connectors are located at the end of short cables while they are fixed on the body for the XML-S stages.



The pinout diagrams for XM-S stage connectors are shown below.

4.3.1 Motor Connector

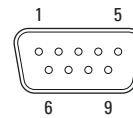

SUB-D9M	
1	Phase L Motor
2	Phase L Motor
3	Phase M Motor
4	Phase M Motor
5	N.C.
6	Phase N Motor
7	Phase N Motor
8	Ground
9	N.C.

4.3.2 Encoder Connector

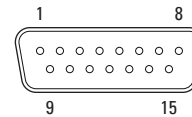

SUB-D15M	
1	Encoder Phase B
2	Ground
3	Encoder Phase A
4	+5 V
5	N.C.
6	Limit
7	Index Pulse /I
8	Home
9	Encoder Phase /B
10	N.C.
11	Encoder Phase /A
12	N.C.
13	N.C.
14	Index Pulse I
15	N.C.

4.3.3 Thermistor Connector

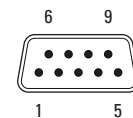

SUB-D9F	
1	Do Not Connect
2	Do Not Connect
3	N.C.
4	N.C.
5	Do Not Connect
6	Thermistor 2
7	Ground
8	Thermistor 1
9	Ground

4.4 Cables

The XM-S stages are supplied without cables.

The appropriate cable kit must be ordered separately, in accordance with the XPS controller configuration used. Please refer to our website for ordering information.



WARNING

The XM-S Series stages operate only with 5-meter max. cables.



WARNING

Cables of the kits are shielded correctly. For a correct operation, make sure to lock connectors (ground continuity provided by the cable).



WARNING

Keep these cables at a safe distance from other electrical cables in your environment to avoid potential cross talk.

5.0 Stage Installation

5.1 Unpacking

The XM-S stages are delivered in packaging designed for safe transport.

- The XMS-S stages are equipped with 1 plate to lock the carriage during transportation.

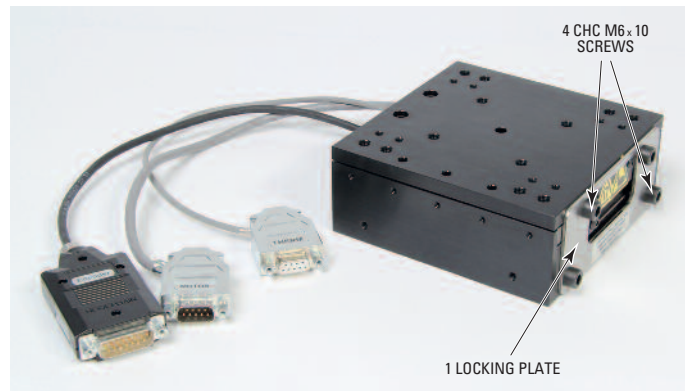

CAUTION

Remove the locking plate before using a XMS-S stage. An Allen key is supplied for CHc M6 screws.

- The XML-S stages are equipped 1 handle on each side which lock the carriage during transportation and safe removal from packaging. It is recommended to carefully lift the stage from packaging using these handles.

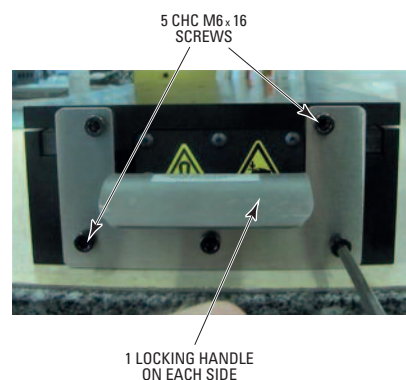

CAUTION

Remove both locking handles before using a XML-S stage. An Allen key is supplied for CHc M6 screws.

6.0 Connection to Newport Controllers

6.1 Warnings on Controllers

Controllers are intended for use by qualified personnel who recognize shock hazards and are familiar with safety precautions required to avoid possible injury. Read the controller user's manual carefully before operating the instrument and pay attention to all written warnings and cautions.

WARNING

Disconnect the power plug under the following circumstances:

- **If the power cord or any attached cables are frayed or damaged in any way.**
- **If the power plug is damaged in any way.**
- **If the unit is exposed to rain, excessive moisture, or liquids are spilled on the unit.**
- **If the unit has been dropped or the case is damaged.**
- **If you suspect service or repair is required.**
- **Whenever you clean the electronics unit.**

CAUTION



To protect the unit from damage, be sure to:

- **Keep all air vents free of dirt and dust.**
- **Keep all liquids away from the unit.**
- **Do not expose the unit to excessive moisture (85% humidity).**
- **Read this manual before using the unit for the first time.**

WARNING

All attachment plug receptacles in the vicinity of this unit are to be of the grounding type and properly polarized.

Contact your electrician to check your receptacles.

WARNING

This product operates with voltages that can be lethal.

Pushing objects of any kind into cabinet slots or holes, or spilling any liquid on the product, may touch hazardous voltage points or short out parts.

6.2 Connection

There is a label on every stage indicating its part and serial numbers.



WARNING

Always turn the controller's power OFF before connecting to a stage.

NOTE



These stages are ESP compatible. Enhanced System Performance is Newport's exclusive technology that enables Newport ESP motion controllers to recognize the connected Newport ESP stage and upload the stage parameters. This ensures that the user can operate the motion system quickly and safely.

6.3 Wiring

The XM-S stages are supplied without cables (see chapter 4.4: "Cables").

7.0 Connection to Non-Newport Electronics

7.1 Connections

WARNING

Newport is not responsible for malfunction or damage of XM-S stages when used with non-Newport controllers.

WARNING

Newport guarantees “C” compliance of XM-S stages only if used with the appropriate Newport cable kit and a XPS series controller.

It is the customer's responsibility to modify the cables and take care of sensor signal connections, when using the stage with non-Newport controllers.



WARNING

+ End-of-Run and - End-of-Run signals are not directly supplied by XM-S Series stages.

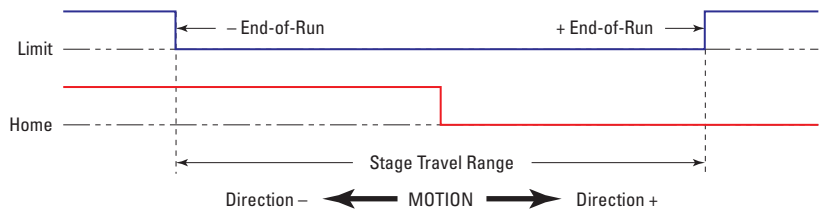

They must be restored using “Limit” and “Home” signals which are generated.

8.0 Dimensions

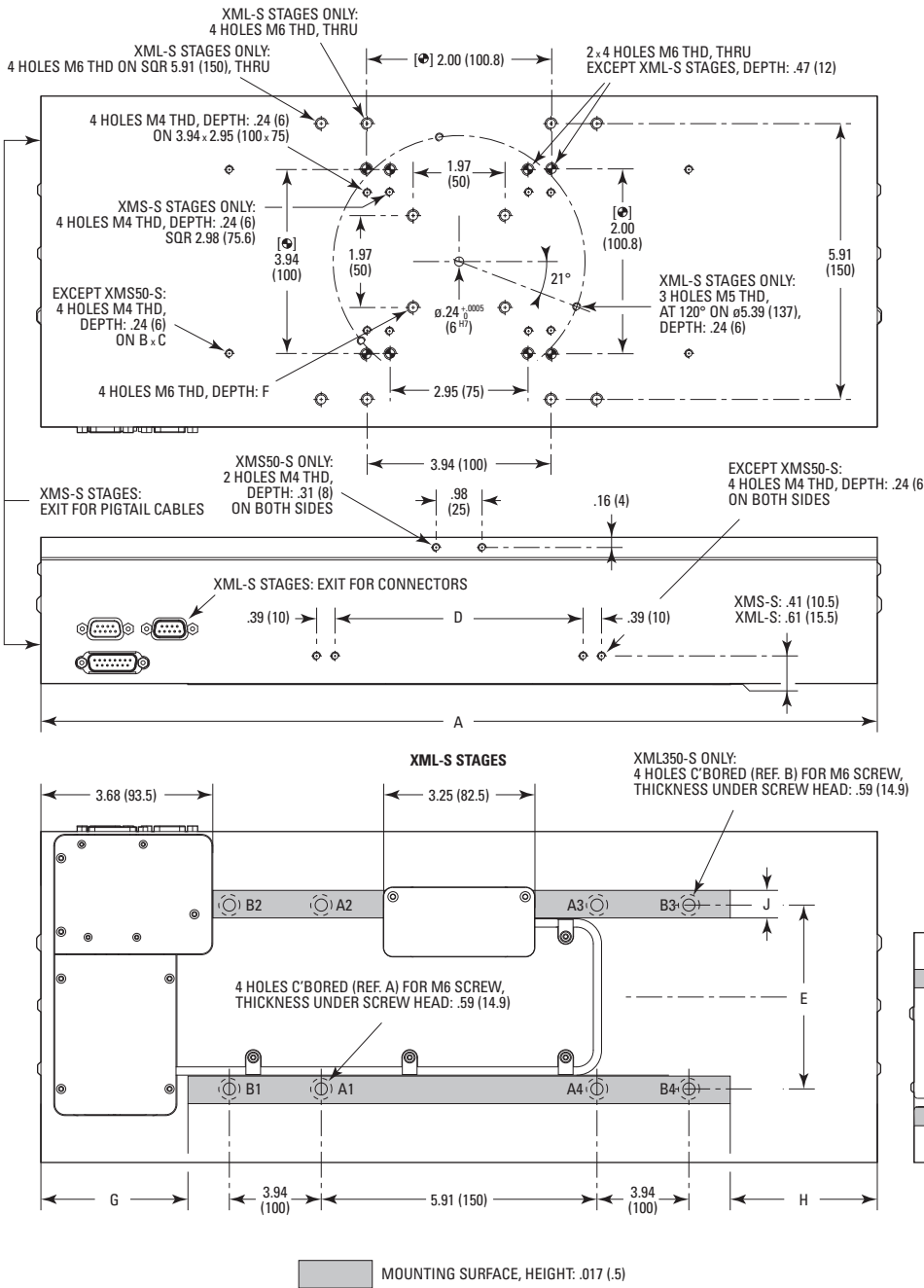

DIMENSIONS IN INCHES (AND MILLIMETERS)

	A	B	C	D	E
XMS50-S	4.92 (125)	-	-	-	2.95 (75)
XMS100-S	7.28 (185)	6.10 (155)	1.77 (45)	5.31 (135)	2.95 (75)
XMS160-S	9.84 (250)	7.28 (185)	1.77 (45)	7.87 (200)	2.95 (75)
XML210-S	13.98 (355)	9.84 (250)	3.94 (100)	5.31 (135)	3.94 (100)
XML350-S	21.85 (555)	9.84 (250)	3.94 (100)	13.19 (335)	3.94 (100)

	F	G	H	J	K
XMS50-S	.28 (7)	-	-	.39 (10)	.28 (7)
XMS100-S	.28 (7)	-	-	.39 (10)	.59 (15)
XMS160-S	.28 (7)	-	-	.39 (10)	.59 (15)
XML210-S	.47 (12)	2.91 (74)	2.66 (67.5)	.59 (15)	-
XML350-S	.47 (12)	3.15 (80)	3.15 (80)	.59 (15)	-

XMS-S & XML-S STAGE CONNECTORS:
 SUB-D9M FOR MOTOR
 SUB-D9F FOR END-OF-RUNS & THERMISTANCE
 SUB-D15M FOR ENCODER

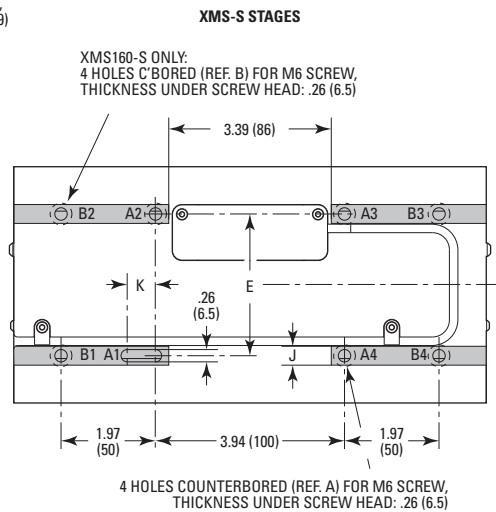
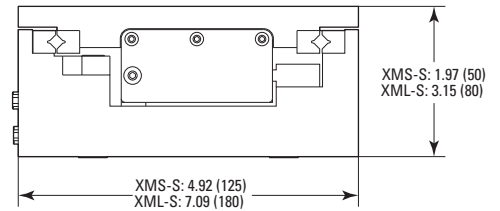

CAUTION

Mounting screws of XM-S stage magnetic channels are accessible via the external side of the top plate. They mustn't be unscrewed; this may damage stage specifications.

9.0 Accessories

9.1 Granite Base for Ultra Surface Flatness

The flatness of the surface is a major factor in the positioning accuracy and repeatability of a motion system. Polished granite plates are among the flattest, commercially available surfaces. Granite’s tight flatness tolerance and extreme hardness make it logical option to complement Newport’s Ultra-Precision Linear Motor XM-S Series stage.

The GB series granite base plates (to order separately) feature 3 point mounting, to make-up for non-flat tables. Edge handles facilitate handling and locating the base plate on the work surface.

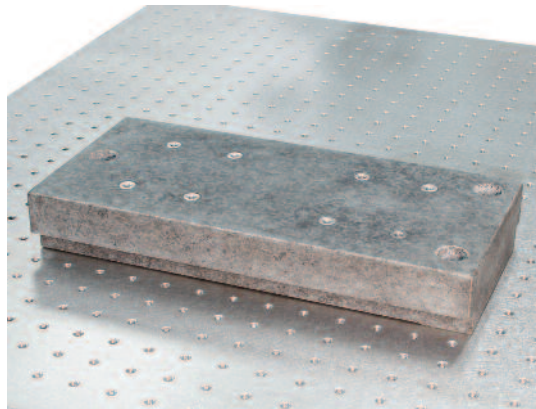

Model	Description
GB50	Granite Base for XMS50
GB100	Granite Base for XMS100
GB160	Granite Base for XMS160
GB210	Granite Base for XML210
GB350	Granite Base for XML350

10.0 Maintenance

RECOMMENDATION

Please contact Technical Sales Support team for recommendations on application specific maintenance.

10.1 Maintenance

The XM-S stage requires no particular maintenance. Nevertheless, this is a precision mechanical device that must be kept and operated with caution.

PRECAUTIONS

The XM-S stage must be used or stocked in a clean environment, without dust, humidity, solvents or other substances.

RECOMMENDATION

It is recommended to return the stage to Newport for re-lubriaction after 2000 hours of use.

If the XM-S stage is mounted on a workstation and cannot be easily removed, please contact Newport's After Sales Service for further instructions.

10.2 Repair

CAUTION



Never attempt to disassemble a component of the stage that has not been covered in this manual.

To disassemble a non specified component can cause a malfunction of the stage.

If you observe a malfunction in your stage, please contact us immediately to arrange for a repair.

CAUTION



Any attempt to disassemble or repair a stage without prior authorization will void your warranty.

10.3 Calibration

CAUTION



It is recommended to return your XM-S stage to Newport once a year for recalibration to its original specifications.

Service Form

Your Local Representative

Tel.: _____
Fax: _____

Name: _____

Return authorization #: _____

(Please obtain prior to return of item)

Company: _____

Address: _____

Date: _____

Country: _____

Phone Number: _____

P.O. Number: _____

Fax Number: _____

Item(s) Being Returned:

Model #: _____

Serial #: _____

Description: _____

Reasons of return of goods (please list any specific problems): _____



Visit MKS | Newport Online at:
www.newport.com

North America & Asia

Newport Corporation
1791 Deere Ave.
Irvine, CA 92606, USA

Sales

Tel.: +1 (949)-863-3144
e-mail: sales@newport.com

Technical Support

Tel.: +1 (949)-863-3144
e-mail: tech@newport.com

Service, RMAs & Returns

Tel.: +1 (949)-863-3144
e-mail: service@newport.com

Europe

MICRO-CONTROLE Spectra-Physics S.A.S
7 rue des Plantes
45340 Beaune-la-Rolande
France

Sales Europe (EMEA)

Tel.: +49 (0) 6151-708-0
e-mail: germany@newport.com

Sales France

Tel.: +33 (0)1 60 91 68 68
e-mail: france@newport.com

Sales UK

Tel.: +44 (0)1235 432 710
e-mail: uk@newport.com

Technical Support

e-mail: tech_europe@newport.com

Service & Returns

Tel.: +33 (0)2 38 40 51 55
DST-BEA-RMA-service@newport.com